

# SunPower Reserve

Home energy storage system

## Quick Installation Guide

### RESERVE-BAT-1-DC-4-INT

#### Available Languages:

English .....	2
Deutsch .....	4
Español .....	6
Français .....	8
Italiano .....	10
Nederlands .....	12





NEED MORE HELP?  
If you would like to contact us directly, please visit our official website:  
<https://sunpower.maxeon.com> for more information.

## 1.0 Transport



There is risk of injury if the battery is lifted incorrectly while being transported as the battery weighs 44 kg. Transport the battery always as described below. Handle with care, choose the corresponding handling method according to the weight, and pay attention to safety.

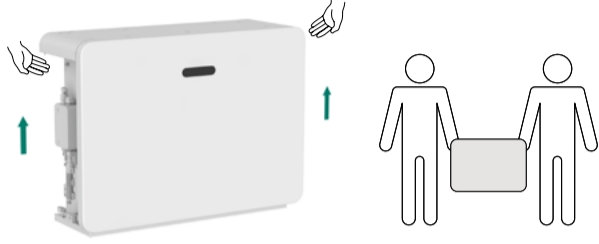

During transportation, please follow these guidelines:

1. The original packaging should be used for transportation.
2. During transportation, please keep the packaging away from dangerous sources and take waterproofing measures.
3. Secure the packaging during transportation.

## 2.0 Product Overview

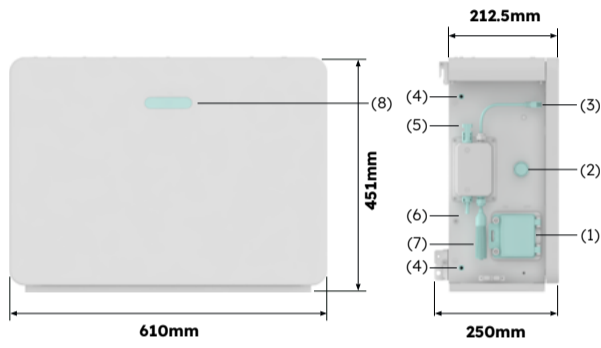

Position	Description
1	Battery Start Breaker
2	Pressure Relief Valve
3	BMS COM (1)
4	Grounding point
5	Battery+ Power Connector
6	Battery- Power Connector
7	BMS COM (2) (with terminal resistor)
8	Battery LED Display

## 2.1 LED Display

The three LEDs on the front cover provide information about the State of Charge (SOC) or Operating State of the battery.

State of Charge (SoC)	Description
	SOC≤10%
	10%<SOC≤30%
	30%<SOC≤50%
	50%<SOC≤60%
	60%<SOC≤90%
	90%<SOC≤100%

Symbol	Description
	White LEDs is flashing
	White LED is glowing
	LEDs is off
	Yellow LED is flashing
	Yellow LED is glowing

Operating State Description
Standby: all white LEDs are flashing (0.5s on and 0.5s off)
Normal: white LEDs are glowing or flashing (0.5s on and 1.5s off)
Protection: yellow LEDs are glowing or flashing (0.5s on and 0.5s off)
Error: yellow LEDs are glowing or flashing (0.5s on and 0.5s off)
Shutdown: all LEDs are off

## 2.2 Minimum Clearances



For additional batteries, keep a minimum spacing of 300mm. Local regulations may impact the positioning and mounting of the battery.

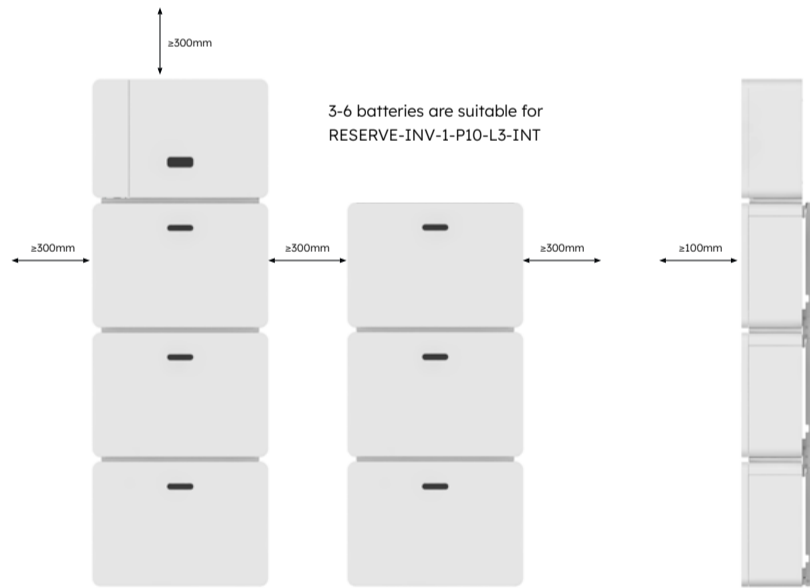
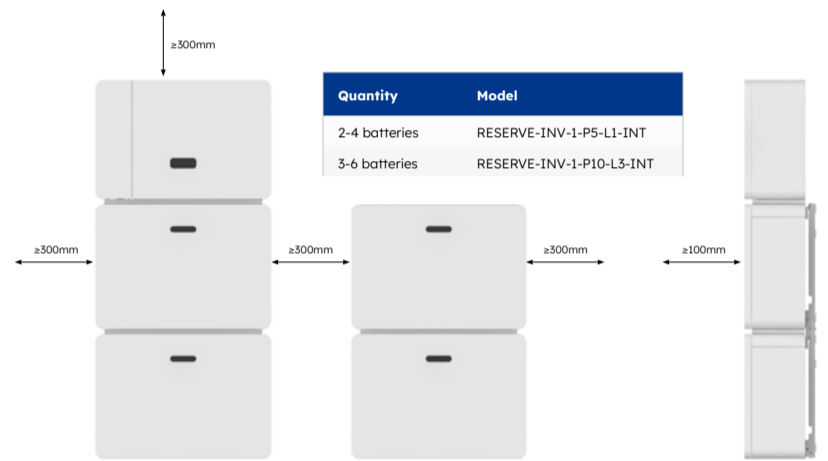

## 2.3 Scope of Delivery

### BATTERY (RESERVE-BAT-1-DC-4-INT)

Battery (x1)	Left Side Plate (x1)	Right Side Plate (x1)	Lower Left Connection Piece (x1)	Lower Right Connection Piece (x1)
Hexagon Head Screws M5x12 (x3)	Grounding Cable 115mm (x1)	Battery Power Cable 205mm (x1)	Cable Tie Buckle (x3)	Plastic Blockage (x1)
Silicone Stopper (x9)	Quick Installation Guide (x1)			

### BATTERY FLOOR MOUNT (SPR-RESERVE-1-DC-4-INT)

Base Unit (x1)	Wall Connection Plate of Base Unit (x1)	Wall Connection Plate of Battery (x1)	Wall Anchor (x6)	Small Spirit Level (x1)
Hexagon Head Screws M5x12 (x8)				

## 2.4 Mounting Location

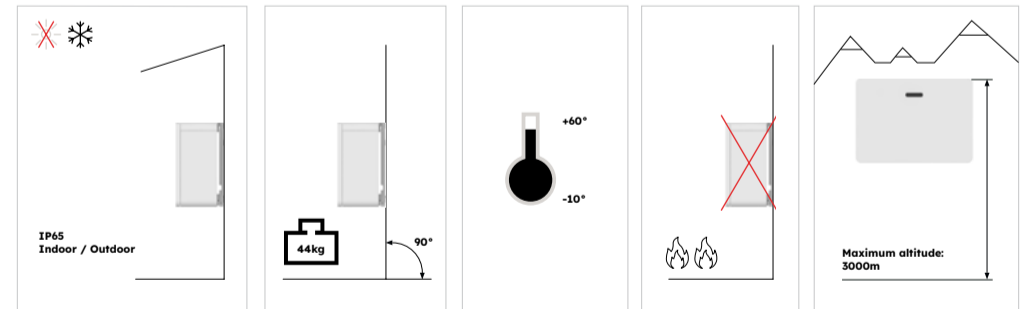

## 2.5 Installation

### 2.5.1 Mounting with base

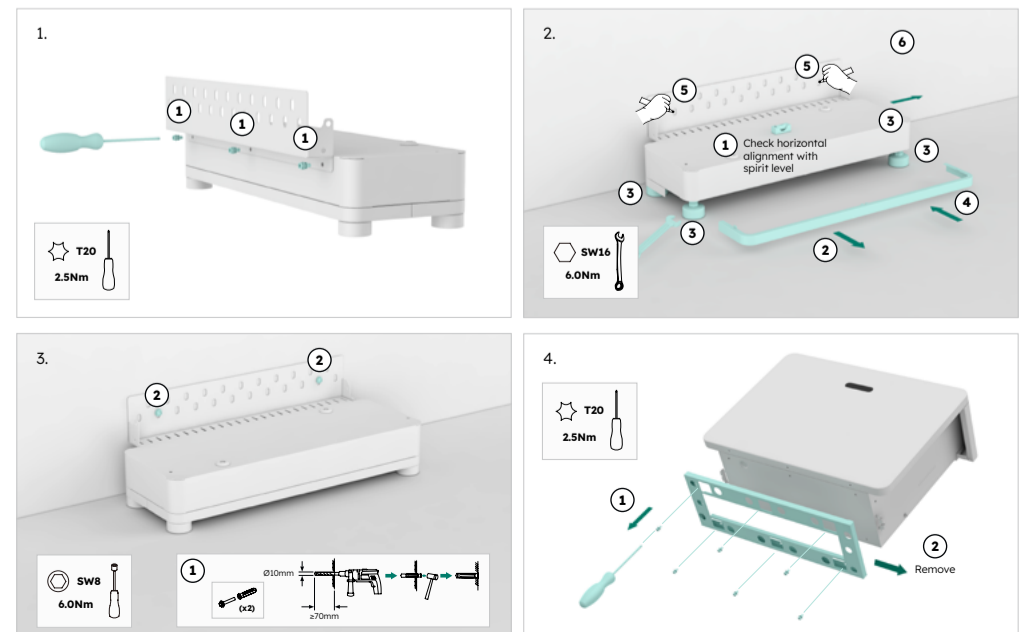

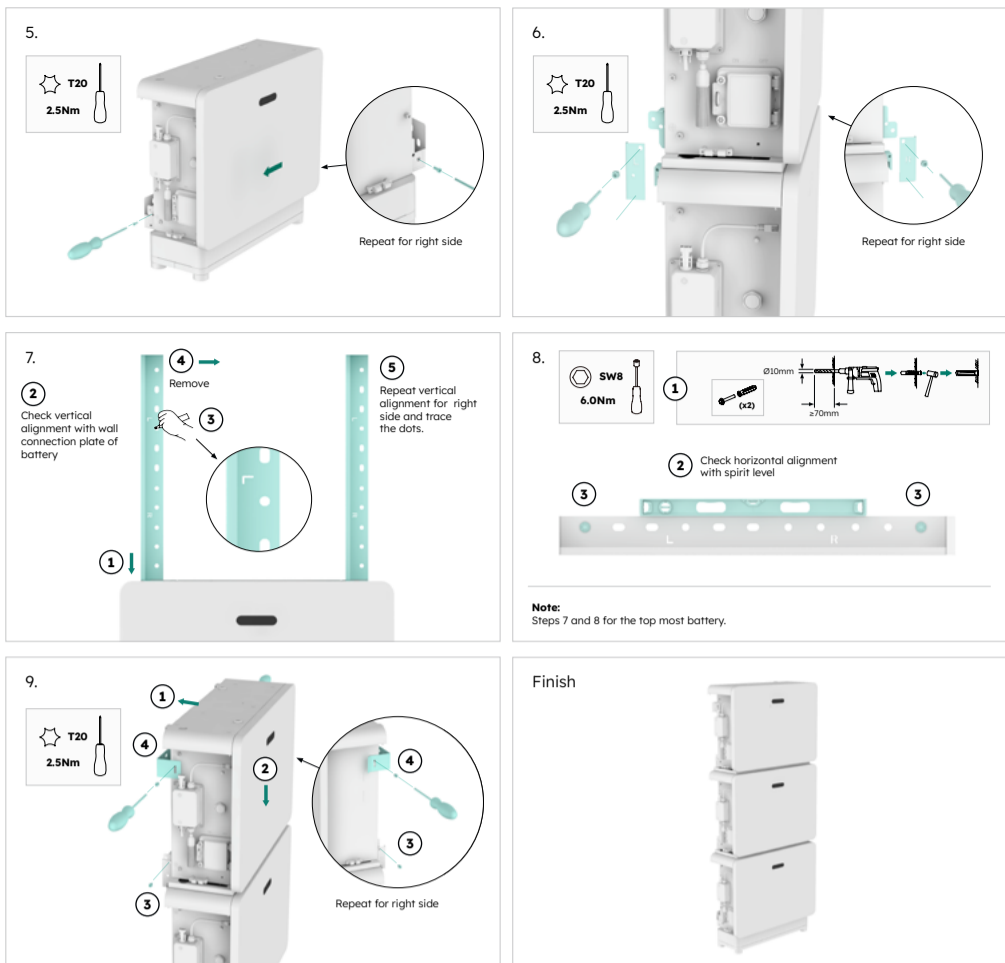

**2.5.2 Wall Mounting**

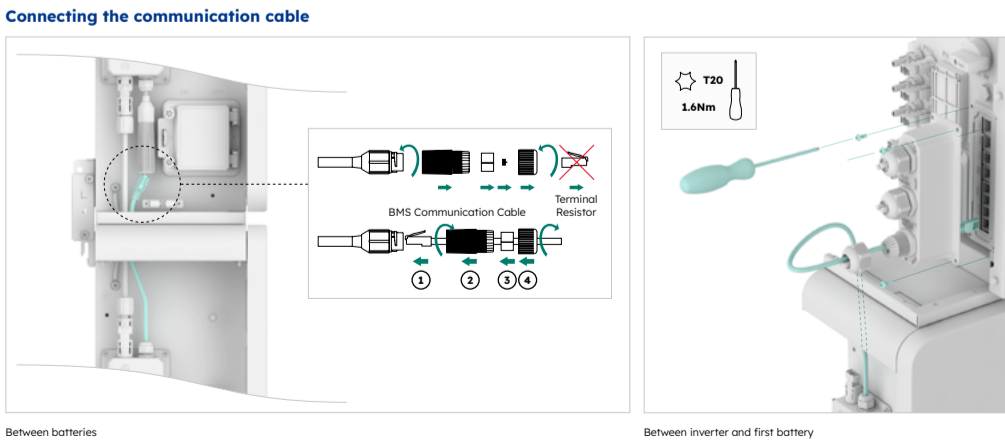
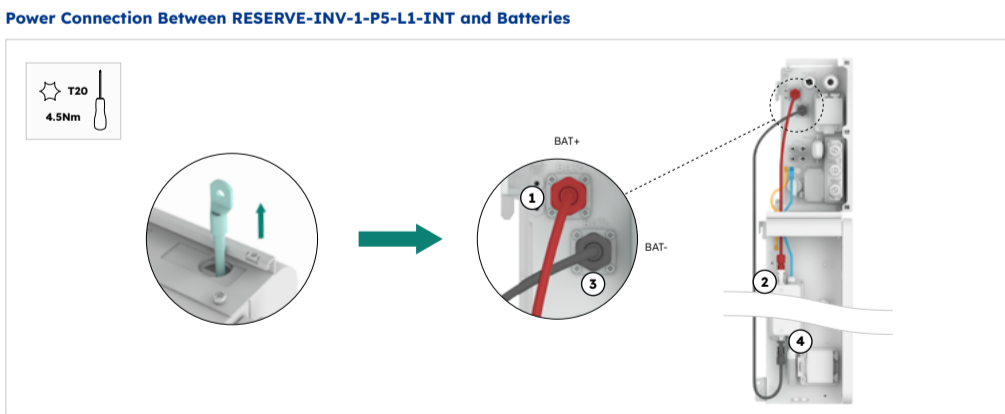
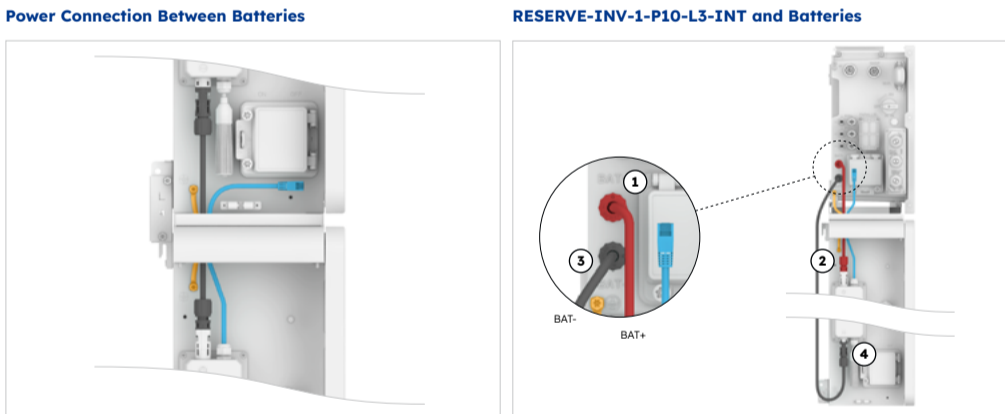
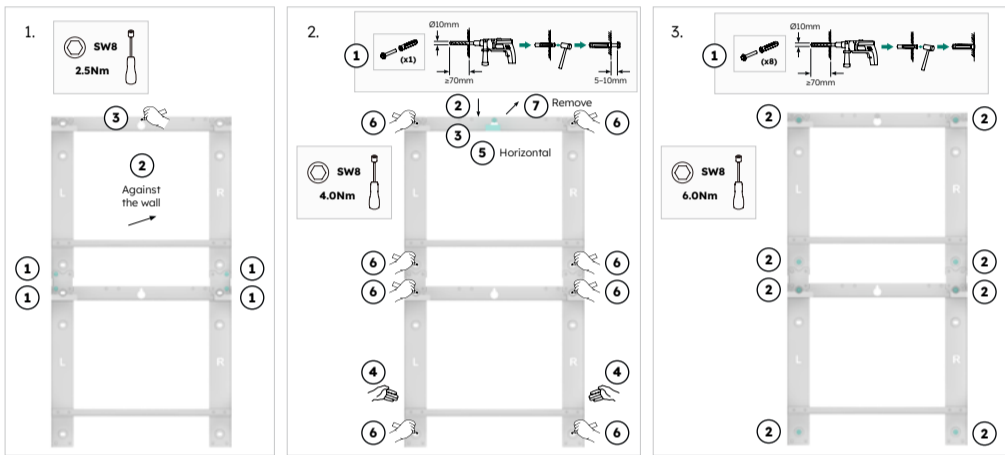

**2.6.3. Connecting more Batteries**

**CAUTION** Connect the cables between the batteries and properly secure the cross battery column cables.

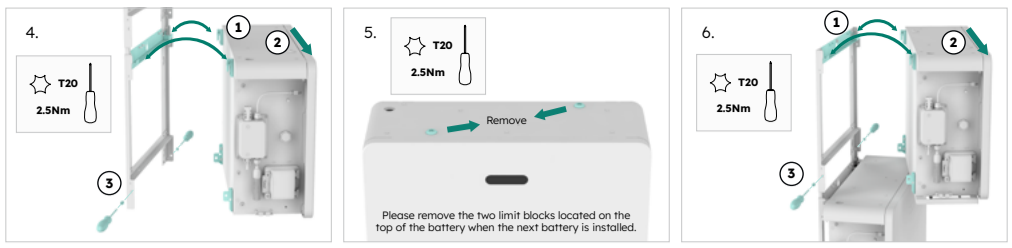

**2.5.3 Mounting of battery ready**

First Battery Installation for Battery Ready Application.

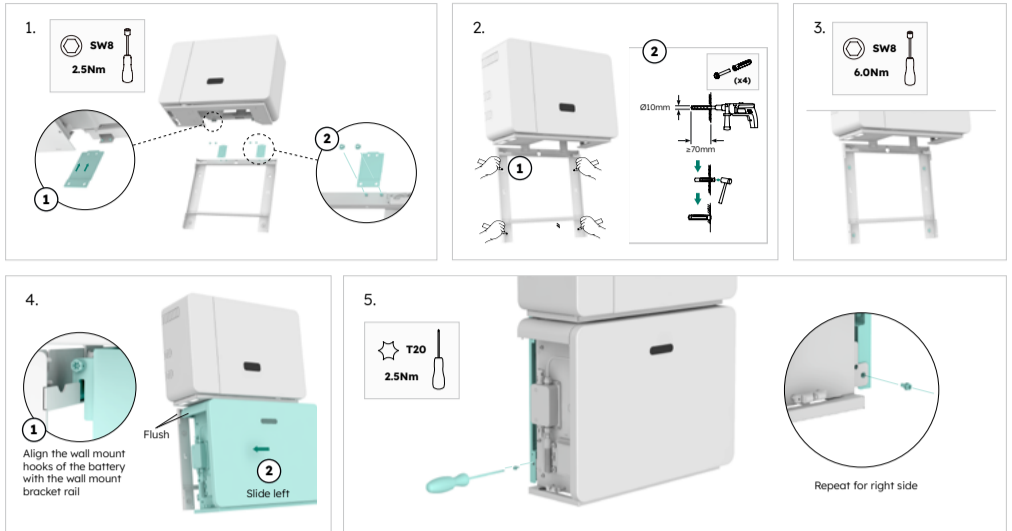

**2.6 Electrical Connection**

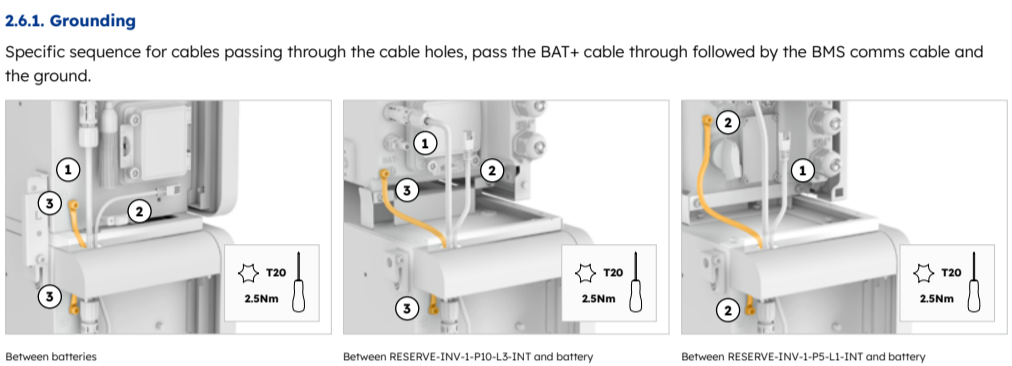

**2.6.2. Connecting to the Inverter Parts**

**WARNING** Danger to life due to short-circuit current. Touching the shorted battery connection may result in lethal injuries due to electric shock and massive energy release.

- Switch off the battery circuit breaker located on the lower left of the battery.
- DO NOT connect the upper connection of a battery to the lower connection as it will result in a short circuit.

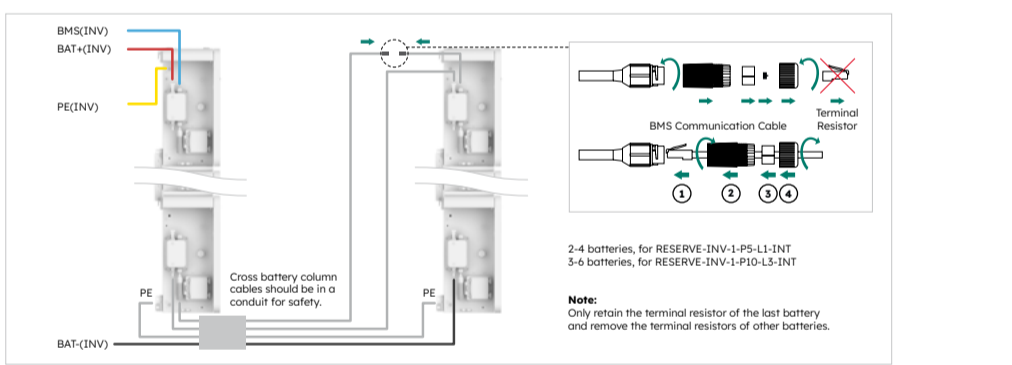

**3.0 Commissioning**



**4.0 Mounting the side Plates**

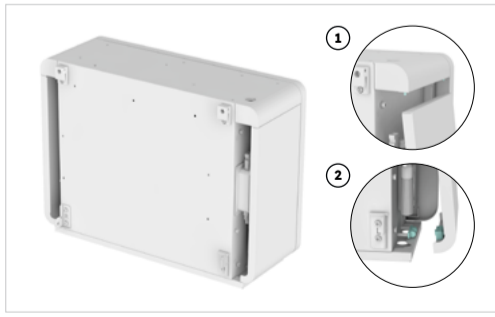

**4.1 Mounting the Plugs**

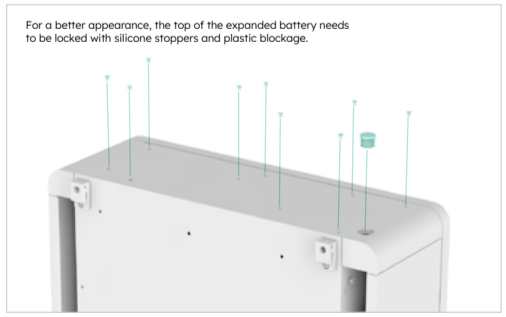

**CAUTION** Disclaimer: This Quick Installation Guide is not replacing Safety and Installation Instructions, it is a short introduction to the product installation. The reference remains the Safety and Installation Instructions.



NEED MORE HELP?  
If you would like to contact us directly, please visit our official website:  
<https://sunpower.maxeon.com> for more information.



BENÖTIGST DU WEITERE HILFE?  
Wenn du uns direkt kontaktieren möchtest, besuche bitte unsere offizielle Website  
<https://sunpower.maxeon.com>, um mehr zu erfahren.

## 1.0 Transport

**VORSICHT** Da der Akku 44 kg wiegt, besteht Verletzungsgefahr, wenn er beim Transport falsch angehoben wird. Transportiere den Akku stets wie unten beschrieben. Arbeite vorsichtig, wähle die dem Gewicht entsprechende Vorgehensweise, und achte auf deine Sicherheit.

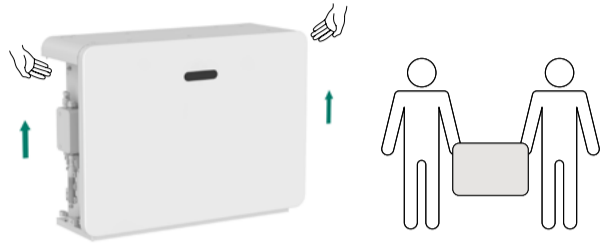

Während des Transports sind folgende Richtlinien zu beachten:

- Der Transport sollte in der Originalverpackung erfolgen.
- Bitte halte die Verpackung während des Transports von Gefahrenquellen fern und treffe wasserabweisende Maßnahmen.
- Sichere die Verpackung für den Transport.

## 2.0 Produktübersicht

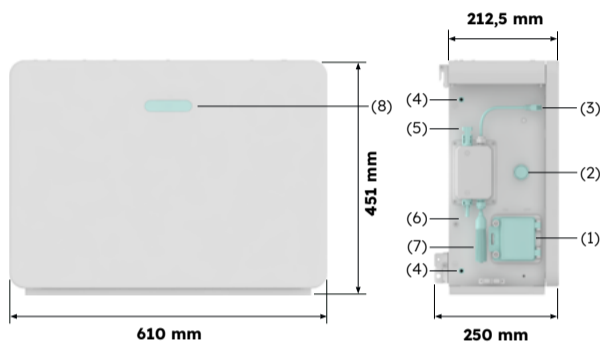

Position	Beschreibung
1	Akku-Start-Schutzschalter
2	Druckbegrenzungsventil
3	BMS COM (1)
4	Erdungspunkt
5	Positiver (+) Pol des Akkus
6	Negativer (-) Pol des Akkus
7	BMS COM (2) (mit Abschlusswiderstand)
8	LED-Anzeige des Akkus

## 2.1 LED-Anzeige

Die drei LEDs auf der Frontabdeckung zeigen den Ladezustand (SOC) oder den Betriebszustand des Akkus an.

Ladezustand (SOC)	Beschreibung
	SOC ≤ 10%
	10% < SOC ≤ 30%
	30% < SOC ≤ 50%
	50% < SOC ≤ 60%
	60% < SOC ≤ 90%
	90% < SOC ≤ 100%

Symbol	Beschreibung
	Weißer LED blinkt
	Weißer LED leuchtet
	LEDs sind aus
	Gelber LED blinkt
	Gelber LED leuchtet

Betriebsstatus – Beschreibung
Standby: alle weißen LEDs blinken (0,5 s an und 0,5 s aus)
Normal: weiße LEDs leuchten oder blinken (0,5 s an und 1,5 s aus)
Schutz: gelbe LEDs leuchten oder blinken (0,5 s an und 0,5 s aus)
Fehler: gelbe LEDs leuchten oder blinken (0,5 s an und 0,5 s aus)
Abschaltung: alle LEDs sind aus

## 2.2 Mindestabstände

**VORSICHT** Zusätzliche Akkus erfordern einen Mindestabstand von 300 mm. Positionierung und Montage des Akkus kann durch örtliche Vorschriften geregelt sein.

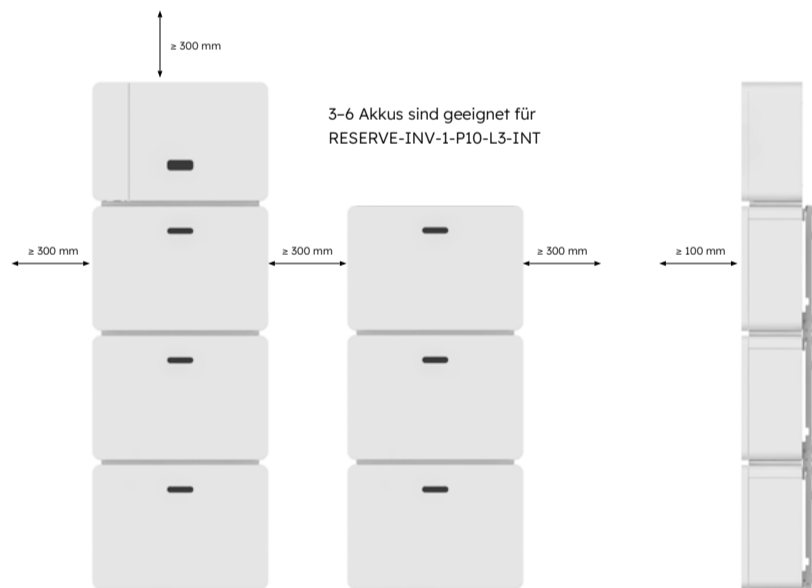
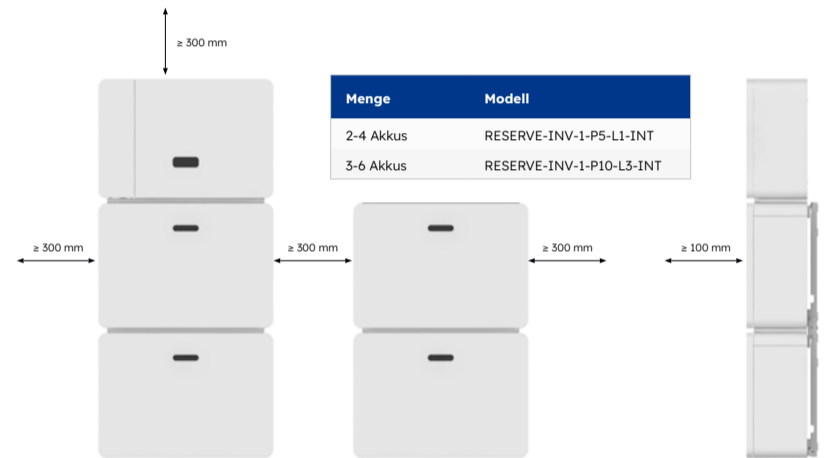

## 2.3 Lieferumfang

AKKU (RESERVE-BAT-1-DC-4-INT)				
Akku (x 1)	Seitenverkleidung links (x 1)	Seitenverkleidung rechts (x 1)	Anschlussstück unten links (x 1)	Anschlussstück unten rechts (x 1)
Sechskantschrauben M5x12 (x 5)	Sechskantschrauben M5x12 (x 3)	Stromkabel für Akku 205 mm (x 1)	Kabelbinderschnalle (x 3)	Kunststoffstopfen (x 1)
Silikonstopfen (x 9)	Schnell-Installationsanleitung (x 1)			

AKKU-BODENHALTERUNG (SPR-RESERVE-1-DC-4-INT)				
Socketeinheit (x 1)	Wandanschlussplatte der Socketeinheit (x 1)	Wandanschlussplatte des Akkus (x 1)	Wanddübel und Schraube (x 6)	Kleine Wasserwaage (x 1)
Sechskantschrauben M5x12 (x 8)				

WANDHALTERUNG (OPTIONAL)				
Wandhalterung (x 1)	Verbindungsplatte zwischen den Wandhalterungen der Akkus (x 2)	Flanschmutter M5 (x 7)	Wanddübel und Schraube (x 6)	Sechskantschraube mit großer Unterlegscheibe M5x12 (x 3)
Verbindungsplatte zwischen den Wandhalterungen des Wechselrichters und des Akkus (x 2)	Kleine Wasserwaage (x 1)			

## 2.4 Installationsort

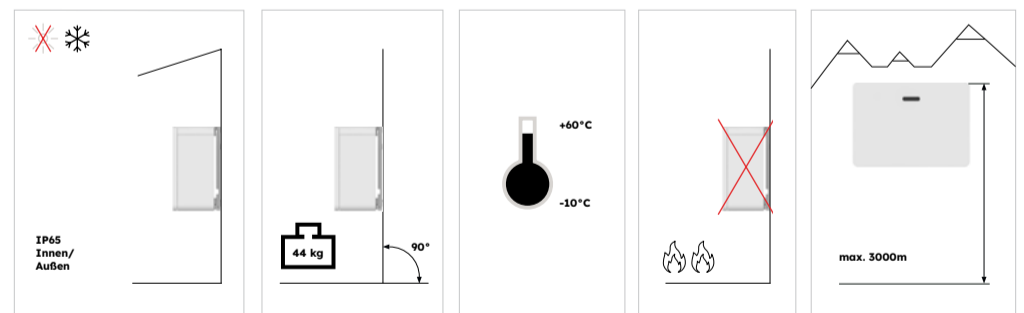

## 2.5 Installation

### 2.5.1 Montage mit Sockel

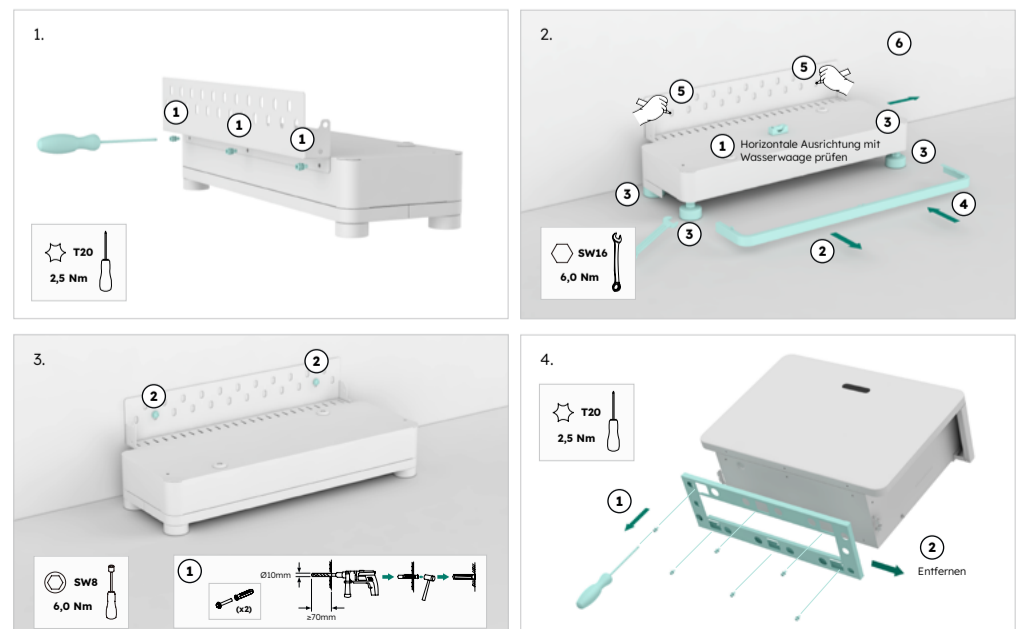

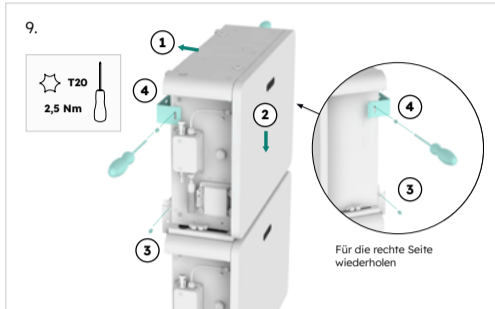
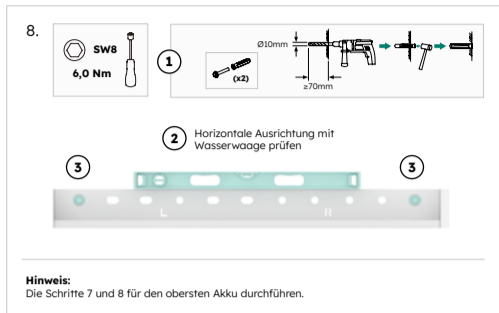
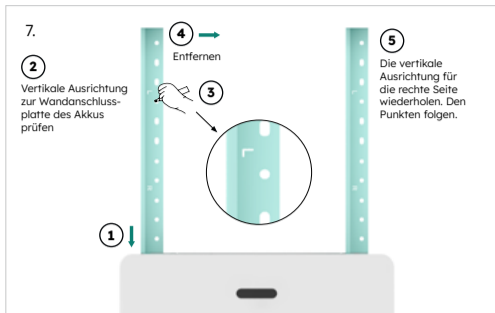
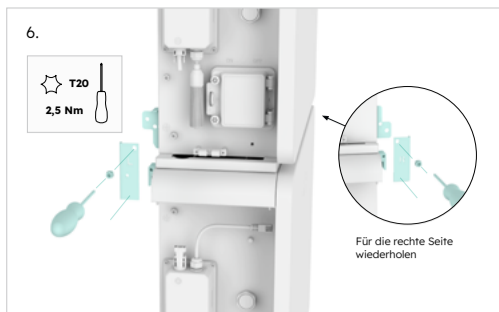
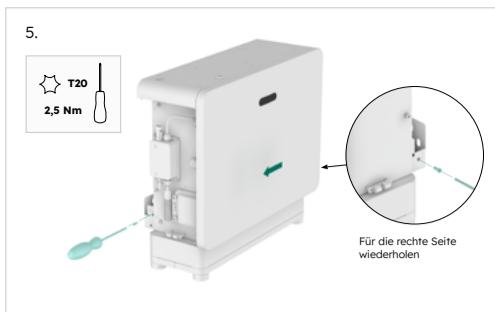

**2.5.2 Wandmontage**

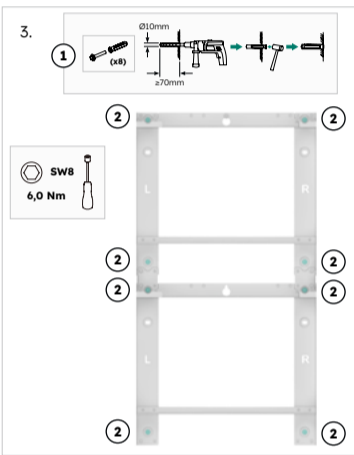
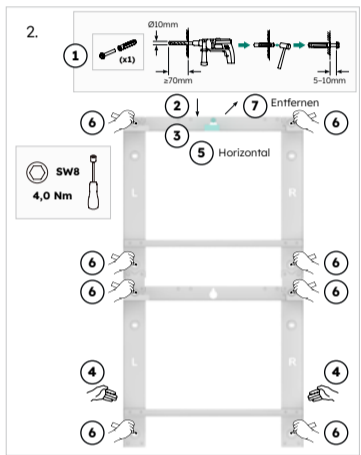
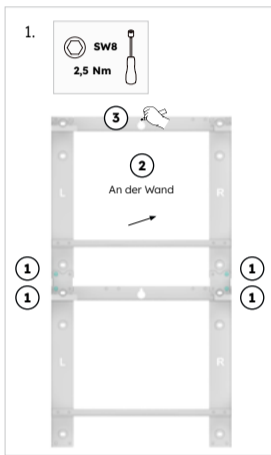

**Stromverbindung zwischen Akkus**

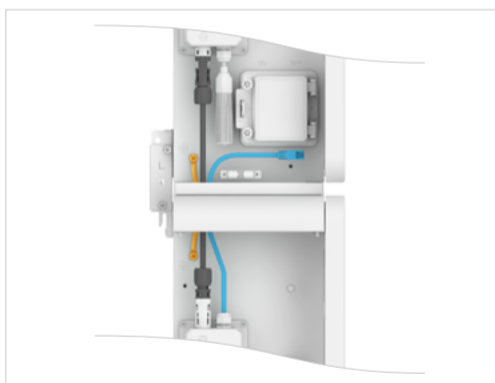

**Stromverbindung zwischen RESERVE-INV-1-P10-L3-INT und Akkus**

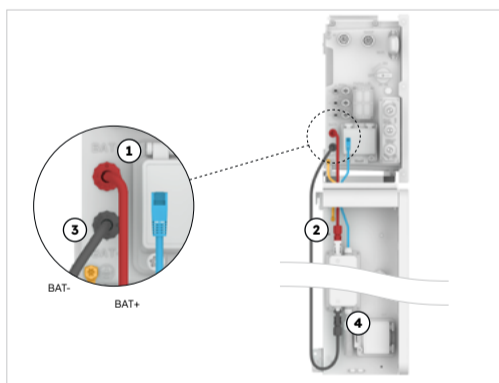

**Stromverbindung zwischen RESERVE-INV-1-P5-L1-INT und Akkus**

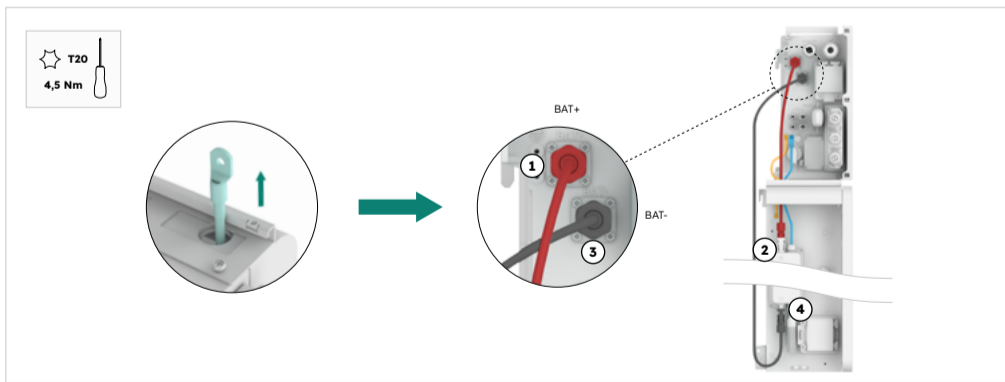

**Anschluss des Kommunikationskabels**

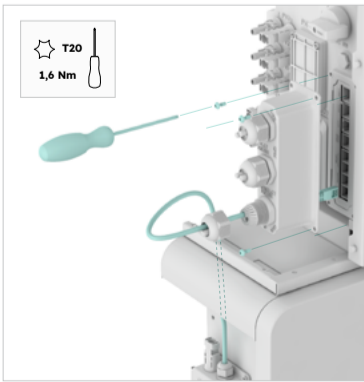
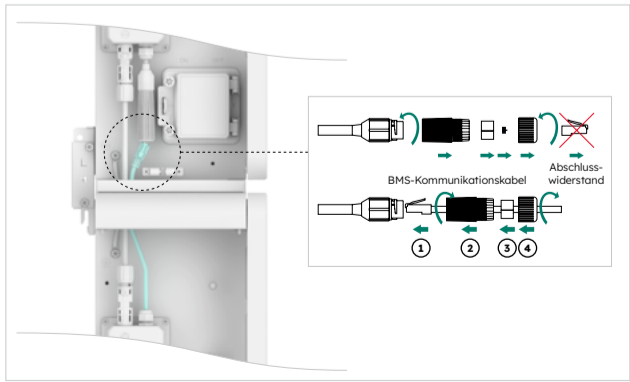

**2.6.3. Weitere Akkus anschließen**

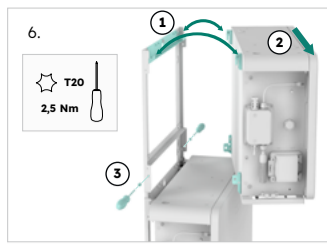
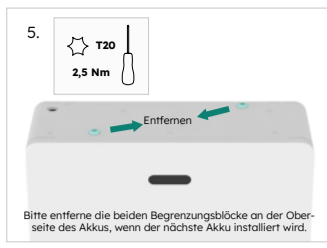
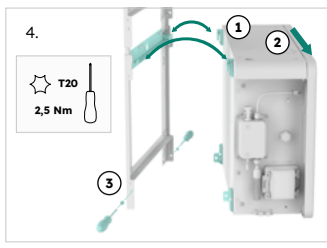
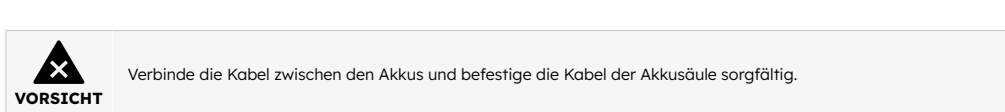

**2.5.3 Montage bei Akkuvorbereitung**

Installation des ersten Akkus bei Akkuvorbereitung.

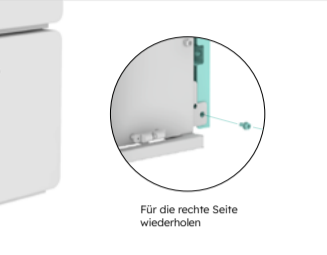
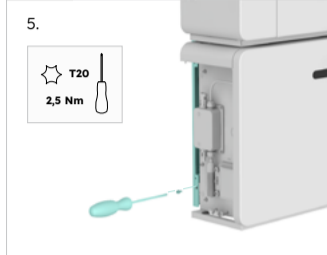
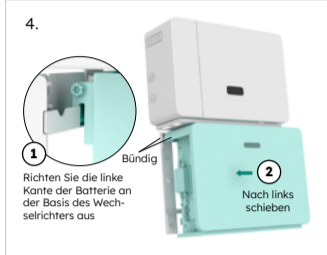
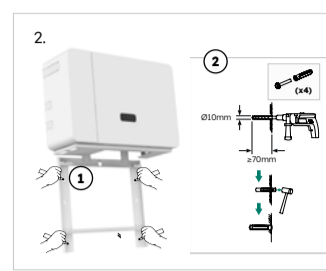
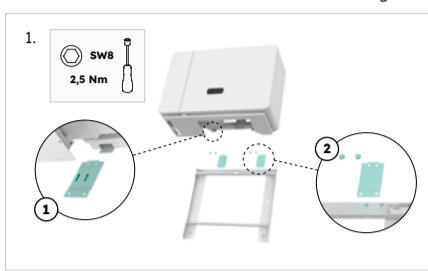

**2.6 Elektrischer Anschluss**

**2.6.1. Erdung**

Reihenfolge, in der die Kabel durch die Kabellöcher geführt werden: Führe das Kabel BAT+ durch, dann das BMS-Kommunikationskabel und die Erdung.

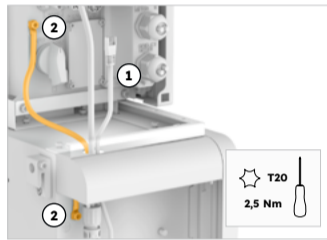
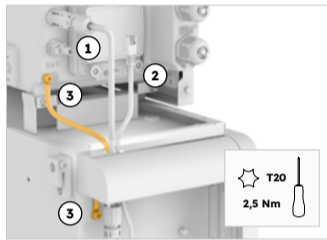
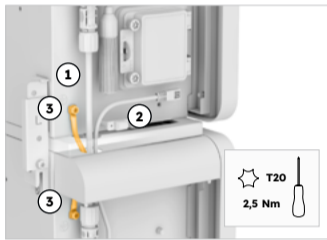

**2.6.2. Anschluss an den Wechselrichter**

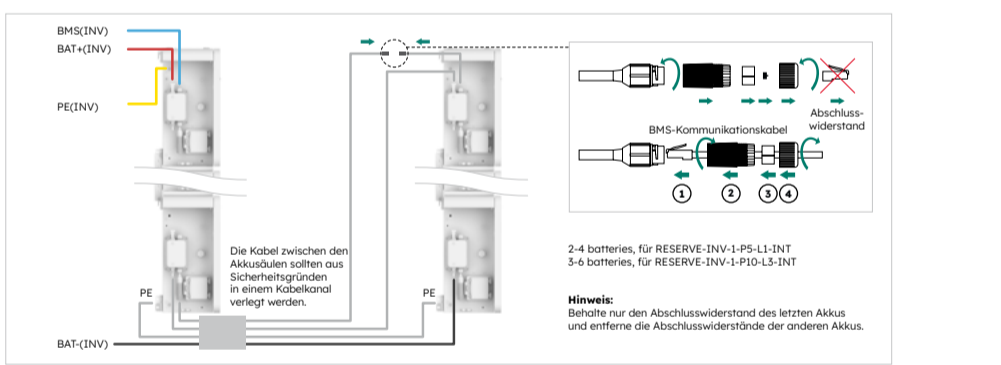
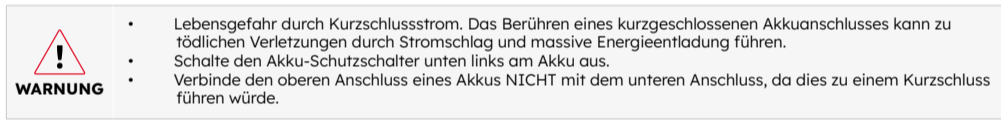

**3.0 Inbetriebnahme**



**4.0 Montage der Seitenverkleidung**



**4.1 Montage der Stopfen**

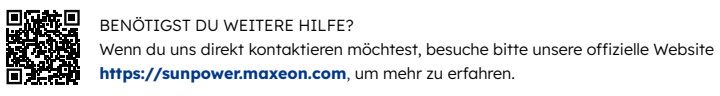
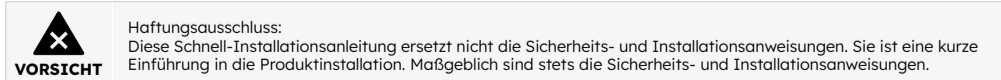

Sicherheits- und Installationsanweisungen für SunPower Reserve



¿NECESITAS MÁS AYUDA?

Si deseas contactarnos directamente, visita nuestro sitio web oficial, donde encontrarás más información:  
<https://sunpower.maxeon.com>

### 1.0 Transporte



Si la batería se levanta incorrectamente durante el transporte, existe riesgo de lesiones, ya que esta pesa 44 kg. Transporta siempre la batería como se describe a continuación. Manipúlala con cuidado, elige el método de manejo correspondiente de acuerdo con el peso y presta atención a la seguridad.

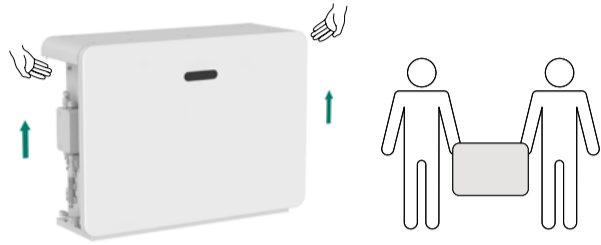

Durante el transporte, sigue estas pautas:

1. Para el transporte debe utilizarse el embalaje original.
2. Durante el transporte, mantén el embalaje alejado de fuentes de peligro y toma medidas de protección contra el agua.
3. Asegura el embalaje durante el transporte.

### 2.0 Descripción general del producto

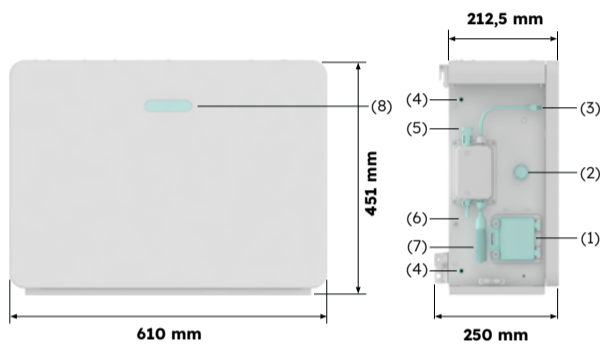

Posición	Descripción
1	Disyuntor de encendido de la batería
2	Válvula de alivio de presión
3	BMS COM (1)
4	Cable de tierra
5	Conector de alimentación de la batería +
6	Conector de alimentación de la batería -
7	BMS COM (2) (con resistencia terminal)
8	Indicador LED de la batería

### 2.1 Pantalla LED

Los 3 LED de la tapa frontal proporcionan información sobre el estado de carga (SOC) o el estado operativo de la batería.

Estado de carga (SoC)	Descripción
	SOC ≤ 10 %
	10 % < SOC ≤ 30 %
	30 % < SOC ≤ 50 %
	50 % < SOC ≤ 60 %
	60 % < SOC ≤ 90 %
	90 % < SOC ≤ 100 %

Símbolo	Descripción
	LED blancos intermitentes
	LED blanco brillando
	Los LED están apagados
	LED amarillo intermitentes
	LED amarillo brillando

Descripción de estado de funcionamiento
Preparado: todos los LED blancos intermitentes (0,5 s encendidos y 0,5 s apagados)
Normal: los LED blancos brillan o se encienden y se apagan de forma intermitente (0,5 s encendidos y 1,5 s apagados)
Protección: los LED amarillos brillan o se encienden y se apagan de forma intermitente (0,5 s encendidos y 0,5 s apagados)
Error: los LED amarillos brillan o se encienden y se apagan de forma intermitente (0,5 s encendidos y 0,5 s apagados)
Apagado: todos los LED apagados

### 2.2 Distancias mínimas



Para baterías adicionales, mantén una separación mínima de 300 mm. La normativa local puede afectar a la colocación y el montaje de la batería.

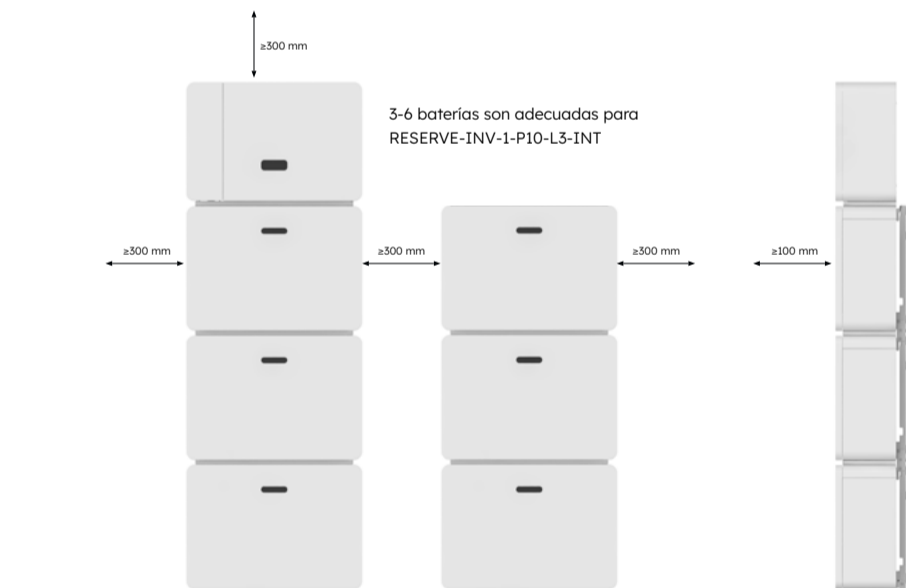
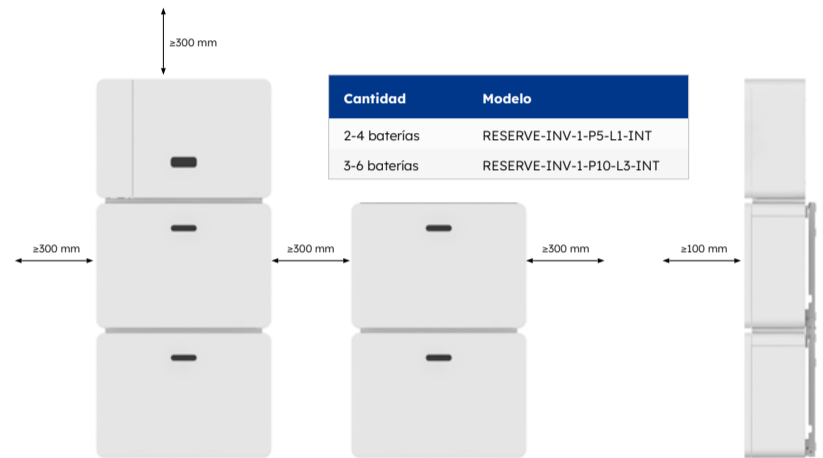

### 2.3 Contenido del paquete

BATERÍA (RESERVE-BAT-1-DC-4-INT)				
Batería (x1)	Cubierta lateral izquierda (x1)	Cubierta lateral derecha (x1)	Pieza de conexión inferior izquierda (x1)	Pieza de conexión inferior derecha (x1)
Tornillos de cabeza hexagonal M5x12 (x3)	Cable de tierra (115 mm) (x1)	Cable de alimentación de la batería 205 mm (x1)	Hebilla sujetacables (x3)	Tapón de plástico (x1)
Tope de silicona (x9)	Guía de instalación rápida (x1)			

SOPORTE DE SUELO PARA BATERÍA (SPR-RESERVE-1-DC-4-INT)				
Unidad base (x1)	Placa de montaje en pared de la unidad base (x1)	Placa de montaje en pared de la batería (x1)	Anclaje de pared (x6)	Nivel pequeño (x1)
Tornillos de cabeza hexagonal M5x12 (x8)				

### SOPORTE DE PARED (OPCIONAL)

Soporte de pared (x1)	Placa de conexión entre los soportes de pared de las baterías (x2)	Tuerca de brida M5 (x7)	Anclaje de pared (x6)	Tornillo de cabeza hexagonal con arandela grande M5x12 (x3)
Placa de conexión entre los soportes de pared del inversor y la batería (x2)	Nivel pequeño (x1)			

### 2.4 Ubicación de montaje

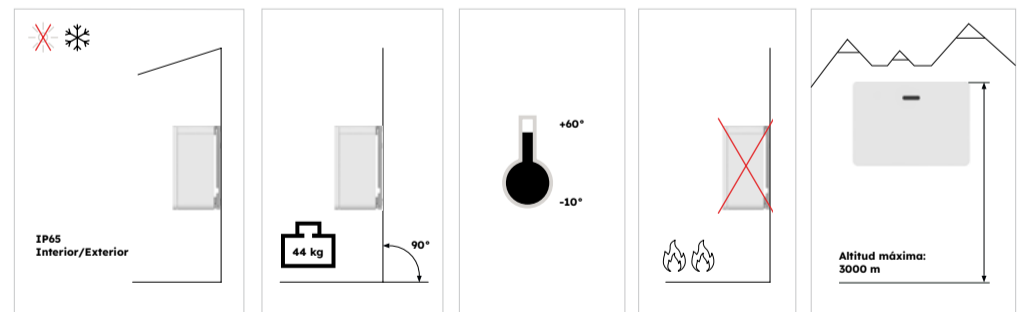

### 2.5 Instalación

#### 2.5.1 Montaje con base

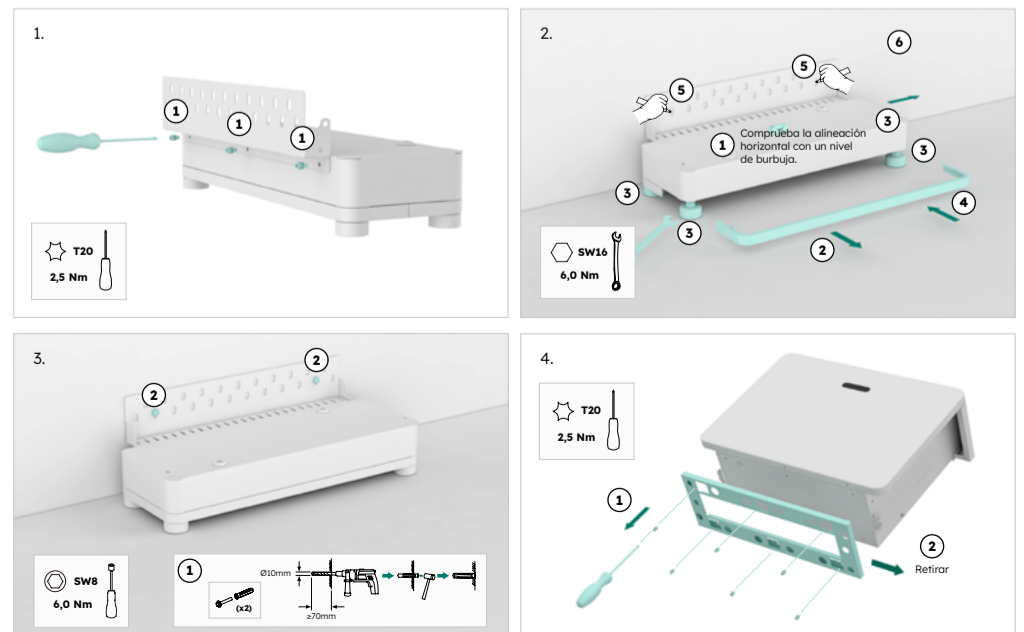

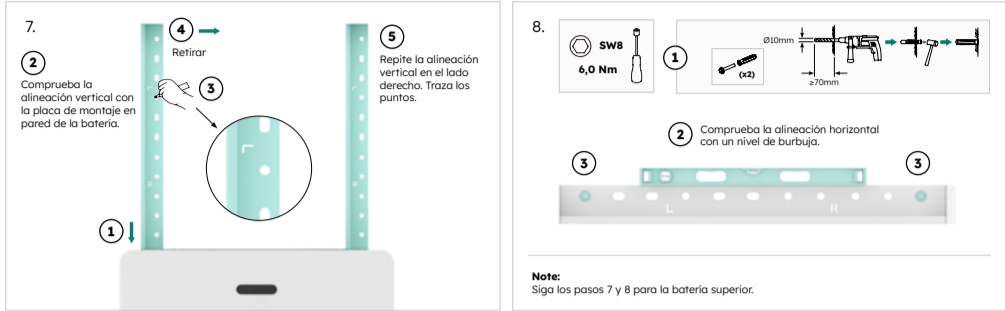
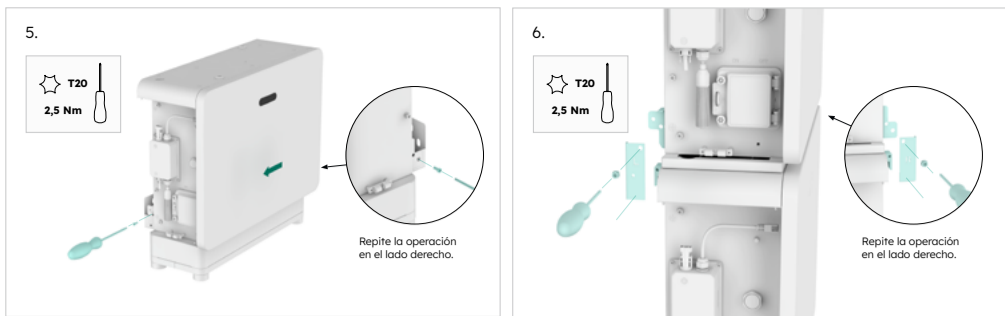

### 2.5.2 Montaje en pared

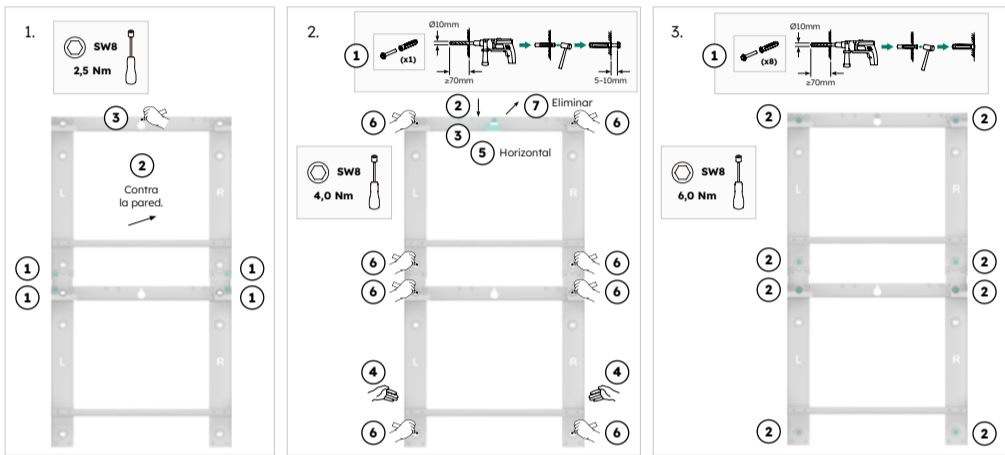

### Conexión eléctrica entre las baterías

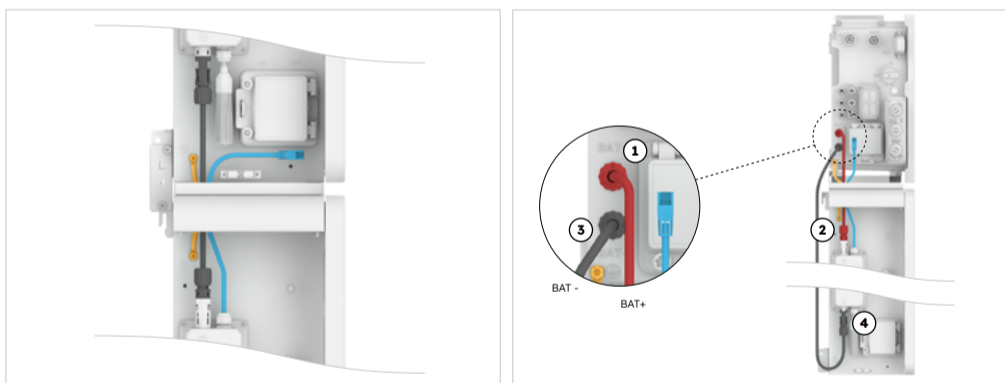

### Conexión de alimentación entre RESERVE-INV-1-P5-L1-INT y las baterías

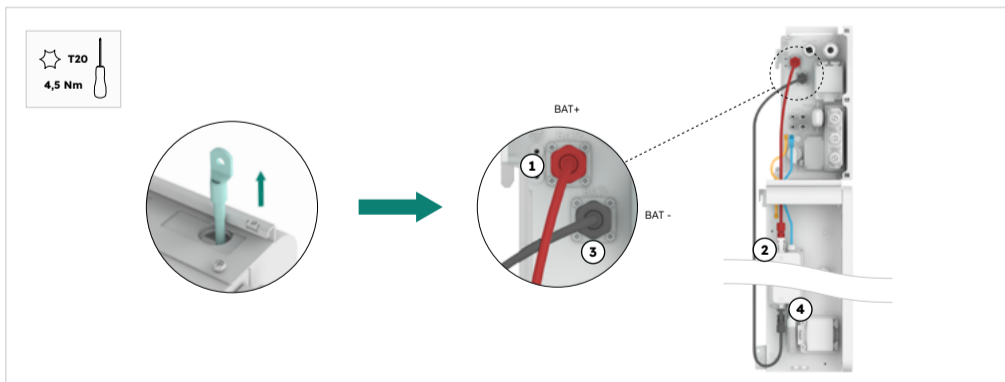

### Conexión del cable de comunicación

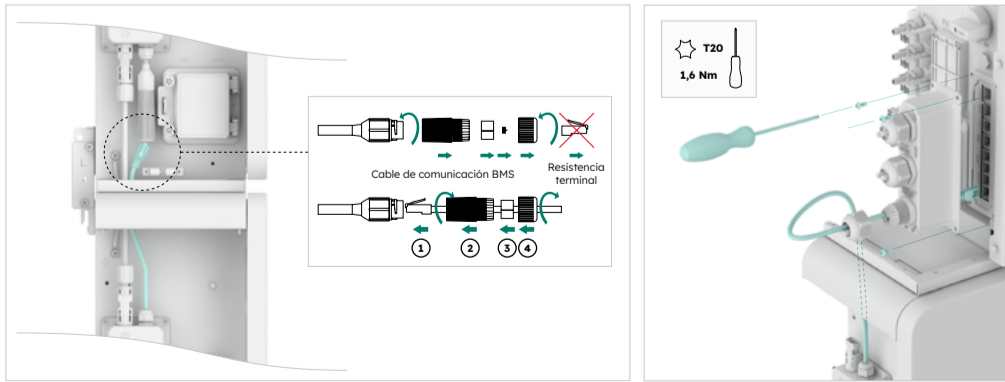

### 2.6.3. Conexión de baterías adicionales

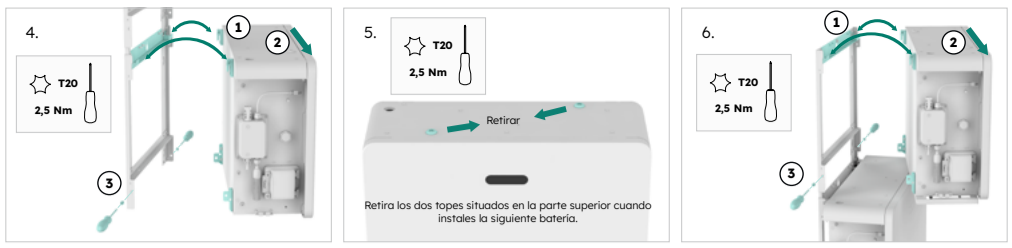
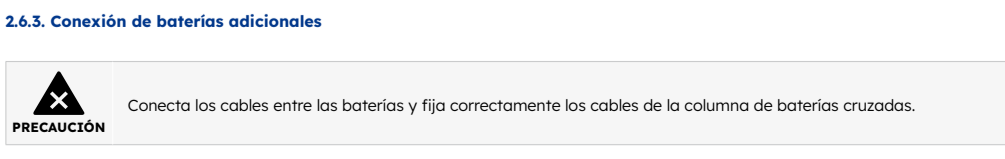

### 2.5.3 Montaje de la batería preparada

Primera instalación de la batería para la aplicación de batería preparada.

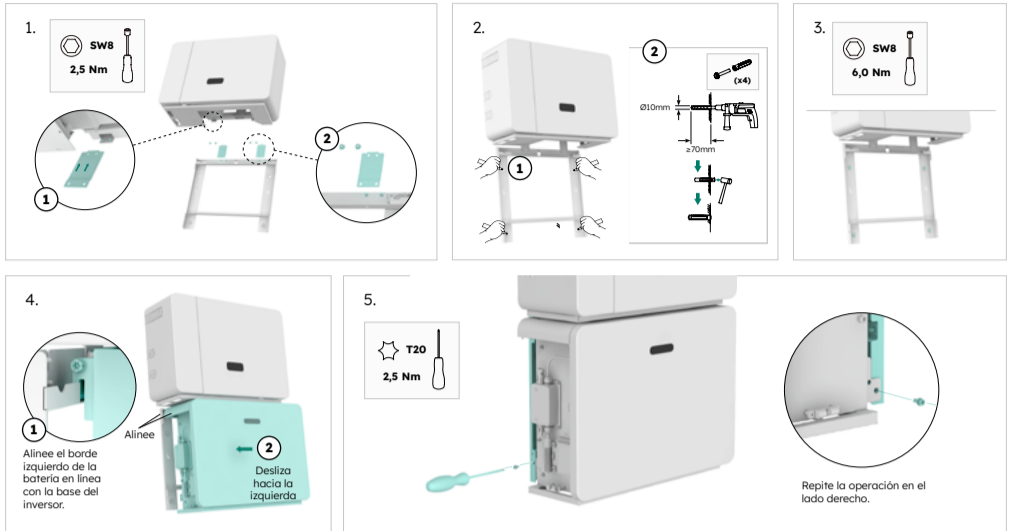

### 2.6 Conexión eléctrica

#### 2.6.1. Conexión a tierra

Secuencia específica para los cables que pasan a través de los orificios para cables: pasa el cable BAT+ seguido del cable de comunicaciones BMS y la toma de tierra.

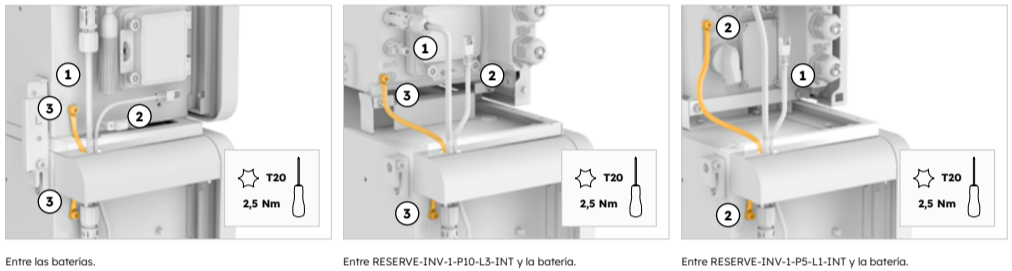

#### 2.6.2. Conexión a los puertos del inversor

**ADVERTENCIA** Peligro de muerte por intensidad de cortocircuito. Tocar la conexión de batería en cortocircuito puede provocar lesiones letales por descarga eléctrica y liberación masiva de energía.

- Apaga el disyuntor que encontrarás en la parte inferior izquierda de la batería.
- NO conectes la conexión superior de una batería a la conexión inferior, ya que se produciría un cortocircuito.

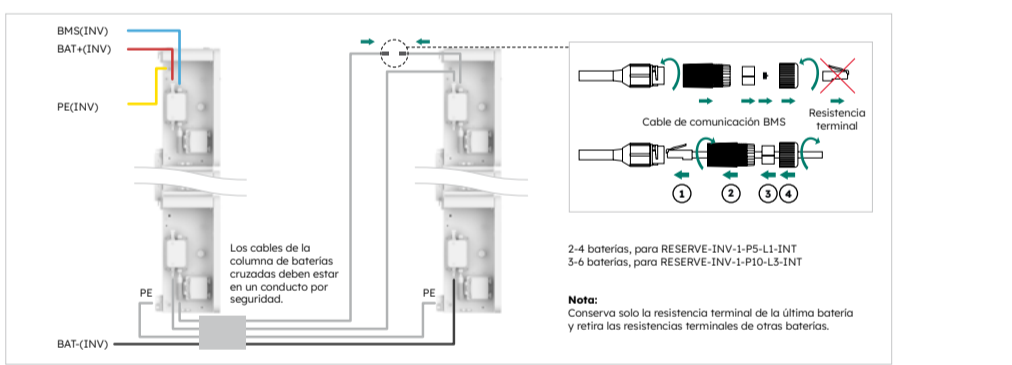

### 3.0 Puesta en servicio



### 4.0 Montaje de las placas



### 4.1 Montaje de los tapones



PRECAUCIÓN Descargo de responsabilidad: Esta guía de instalación rápida no sustituye las instrucciones de seguridad e instalación, tan solo sirve como breve introducción para la instalación del producto. Las instrucciones de seguridad e instalación siguen siendo la referencia principal.



¿NECESITAS MÁS AYUDA?  
Si deseas contactarnos directamente, visita nuestro sitio web oficial, donde encontrarás más información:  
<https://sunpower.maxeon.com>

Instrucciones de seguridad e instalación de SunPower Reserve





VOUS AVEZ BESOIN D'AIDE ?

Si vous souhaitez nous contacter directement, veuillez consulter notre site web officiel <https://sunpower.maxeon.com> pour plus d'informations.

### 1.0 Transport



Il y a un risque de blessure si la batterie est soulevée de manière incorrecte pendant le transport, car elle pèse 44 kg. Transportez toujours la batterie comme décrit ci-dessous. Manipulez-la avec précaution, choisissez la méthode de manipulation appropriée en fonction du poids et veillez à la sécurité.

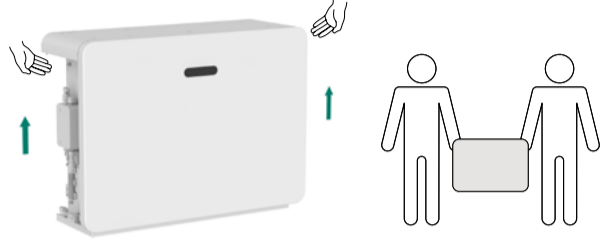

Pendant le transport, veuillez respecter les consignes suivantes :

- Utilisez l'emballage d'origine pour le transport.
- Pendant le transport, tenez l'emballage à l'écart des sources de danger et prenez des mesures de protection contre l'eau.
- Sécurisez l'emballage pendant le transport.

### 2.0 Aperçu du produit

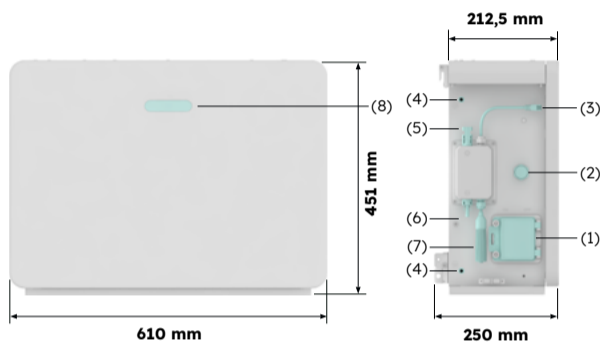

Position	Description
1	Disjoncteur de démarrage de la batterie
2	Soupape de surpression
3	BMS COM (1)
4	Point de mise à la terre
5	Connecteur d'alimentation Batterie+
6	Connecteur d'alimentation Batterie-
7	BMS COM (2) (avec résistance de terminaison)
8	Affichage LED de la batterie

### 2.1 Écran LED

Les trois LED situées sur la face avant fournissent des informations sur l'état de charge (SOC) ou l'état de fonctionnement de la batterie.

État de charge (SOC)	Description
	SOC ≤ 10 %
	10 % < SOC ≤ 30 %
	30 % < SOC ≤ 50 %
	50 % < SOC ≤ 60 %
	60 % < SOC ≤ 90 %
	90 % < SOC ≤ 100 %

Symbole	Description
	La LED blanche clignote
	La LED blanche est allumée
	La LED est éteinte
	La LED jaune clignote
	La LED jaune est allumée

Description de l'état de fonctionnement
Veille : toutes les LED blanches clignotent (0,5 s allumées, 0,5 s éteintes)
Normal : les LED blanches sont allumées ou clignotent (0,5 s allumées, 1,5 s éteintes)
Protection : les LED jaunes sont allumées ou clignotent (0,5 s allumées, 0,5 s éteintes)
Erreur : les LED jaunes sont allumées ou clignotent (0,5 s allumées, 0,5 s éteintes)
Arrêt : toutes les LED sont éteintes

### 2.2 Dégagements minimaux



Pour les batteries supplémentaires, respecter un espacement minimum de 300 mm. Les réglementations locales peuvent avoir une incidence sur le positionnement et le montage de la batterie.

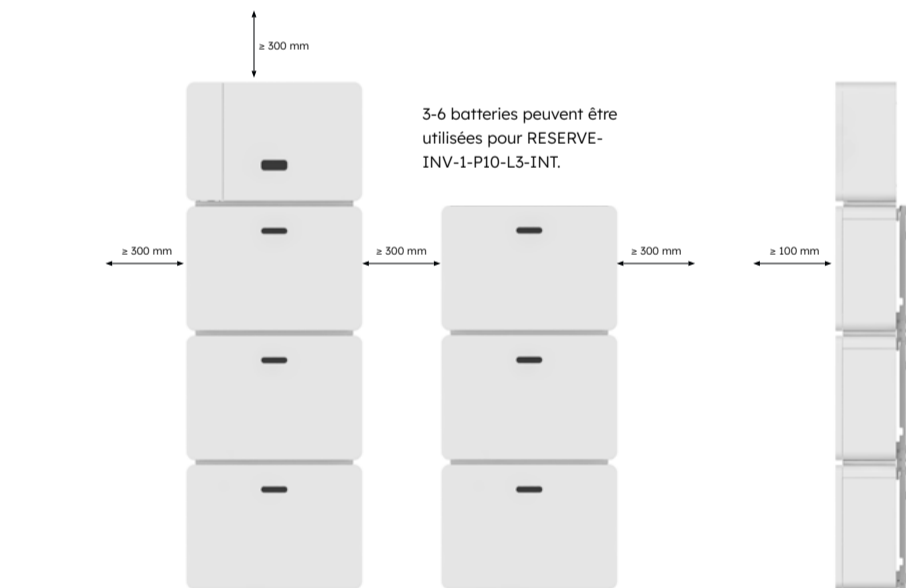
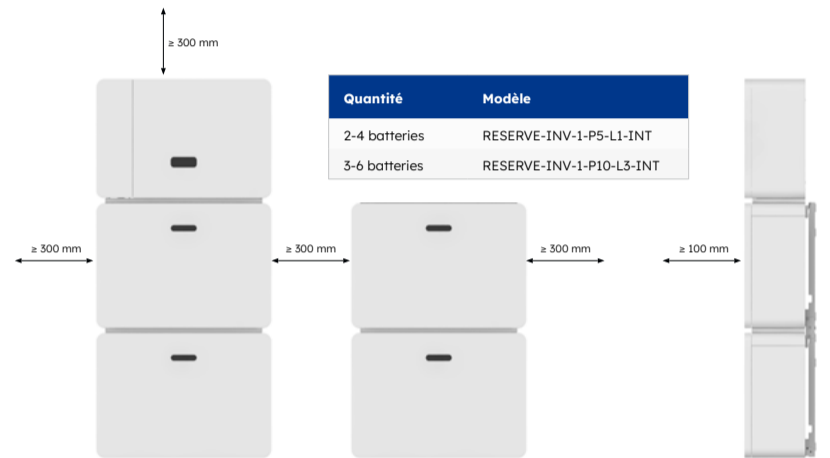

### 2.3 Contenu de la livraison

BATTERIE (RESERVE-BAT-1-DC-4-INT)				
Batterie (x1)	Plaque latérale gauche (x1)	Plaque latérale droite (x1)	Pièce de connexion inférieure gauche (x1)	Pièce de connexion inférieure droite (x1)
Vis à tête hexagonale M5x12 (x3)	Câble de mise à la terre 115 mm (x1)	Câble d'alimentation de batterie 205 mm (x1)	Boucle d'attache de câble (x3)	Dispositif de blocage en plastique (x1)
Bouchon en silicone (x9)	Guide d'installation rapide (x1)			

FIXATION DE BATTERIE AU SOL (SPR-RESERVE-1-DC-4-INT)				
Unité de base (x1)	Plaque de connexion murale de l'unité de base (x1)	Plaque de connexion murale de la batterie (x1)	Dispositif d'ancrage mural (x6)	Petit niveau à bulle (x1)
Vis à tête hexagonale M5x12 (x8)				

SUPPORT MURAL (OPTIONNEL)				
Support mural (x1)	Plaque de connexion entre les supports muraux des batteries (x2)	Écrou à bride M5 (x7)	Dispositif d'ancrage mural (x6)	Vis à tête hexagonale avec grande rondelle M5x12 (x3)
Plaque de connexion entre les supports muraux de l'onduleur et des batteries (x2)	Petit niveau à bulle (x1)			

### 2.4 Emplacement de montage

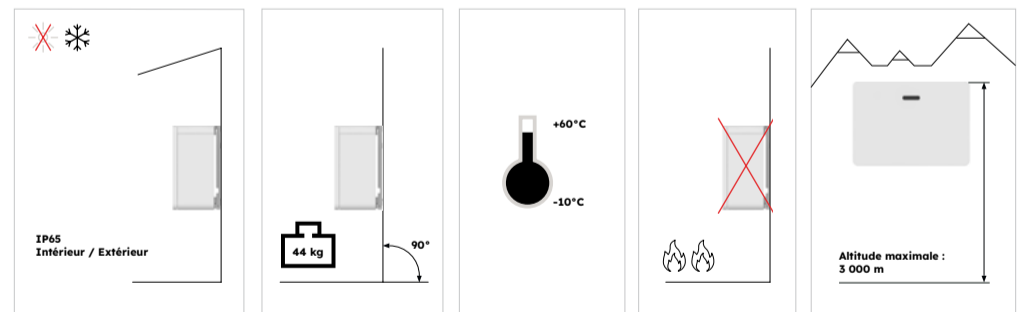

### 2.5 Installation

#### 2.5.1 Montage avec base

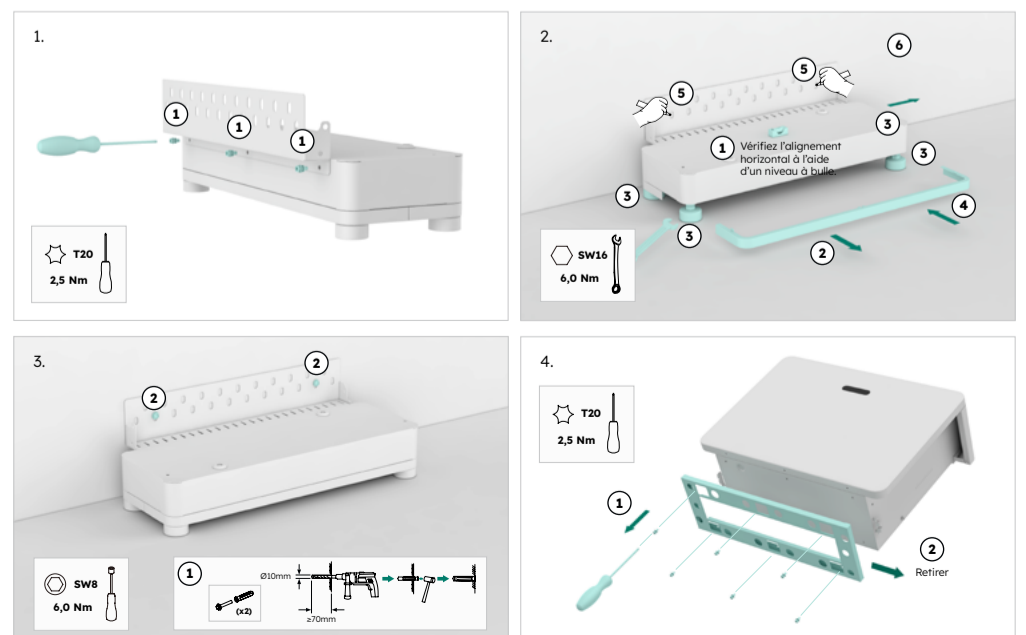



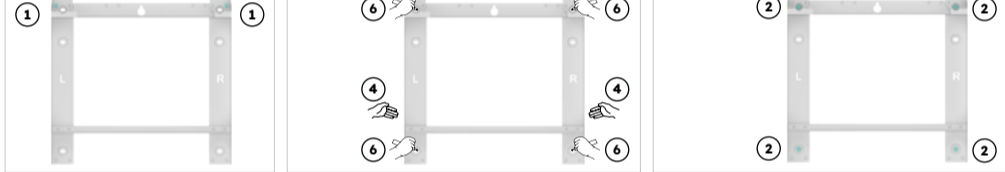
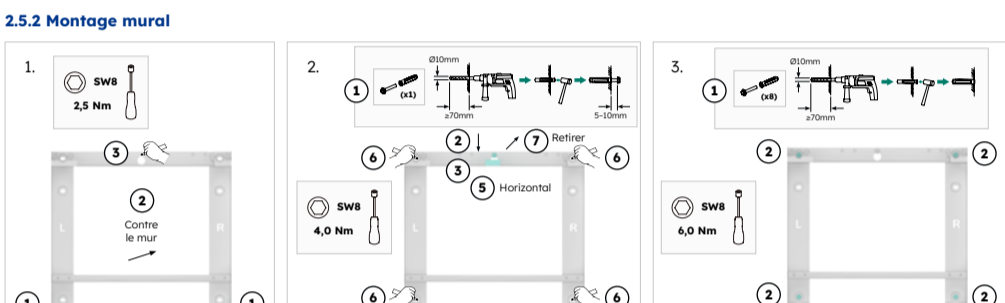
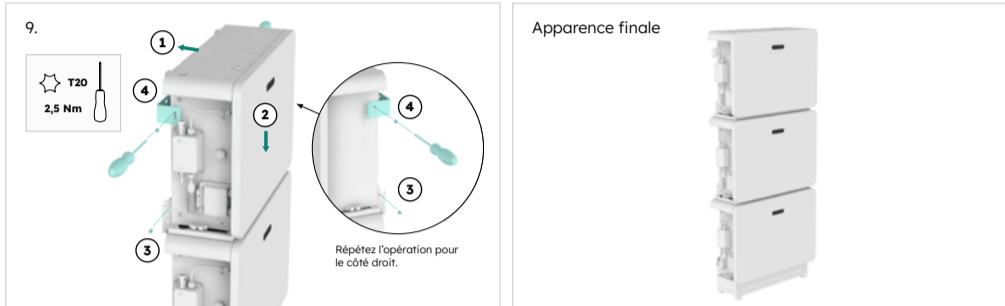
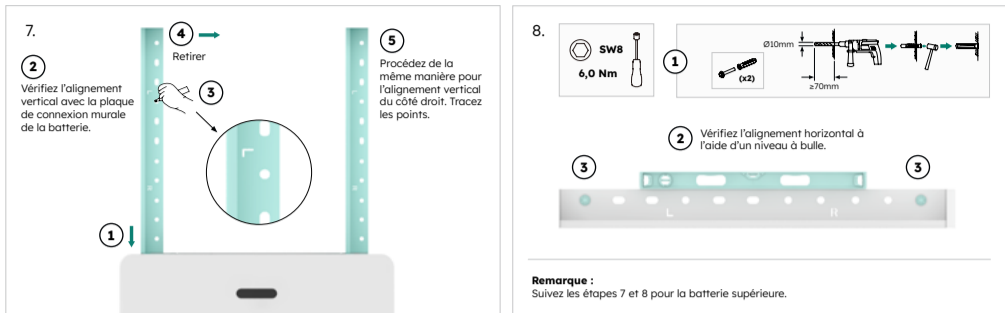
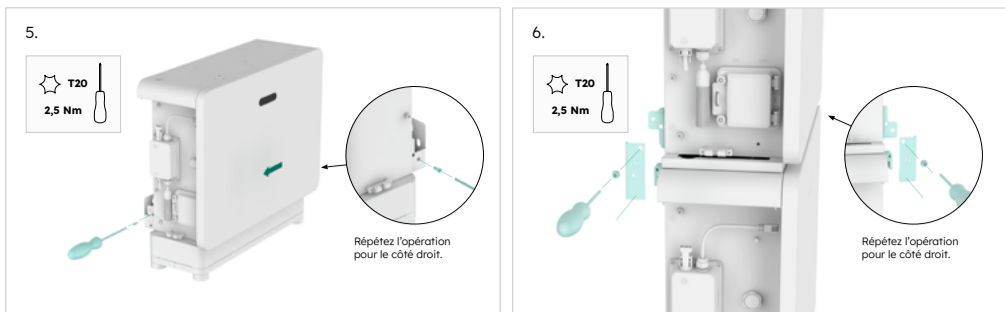

### 2.5.2 Montage mural

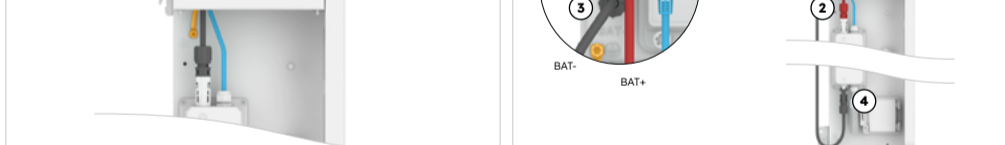
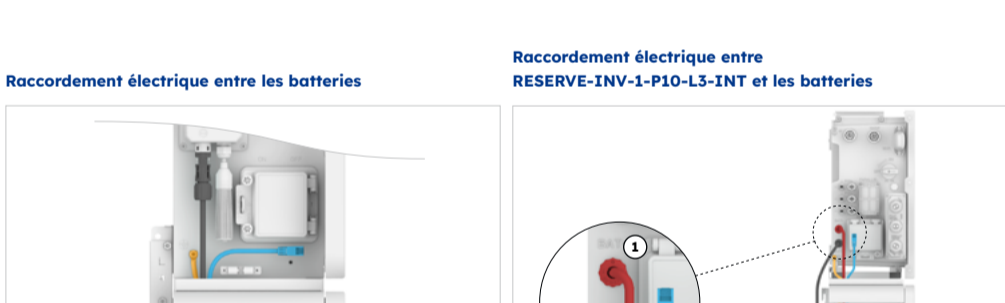

### Raccordement électrique entre les batteries



### Raccordement électrique entre RESERVE-INV-1-P10-L3-INT et les batteries

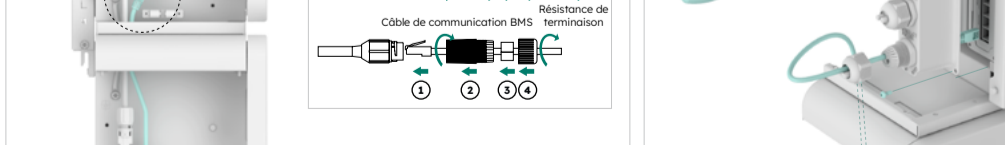

### Raccordement électrique entre RESERVE-INV-1-P5-L1-INT et les batteries

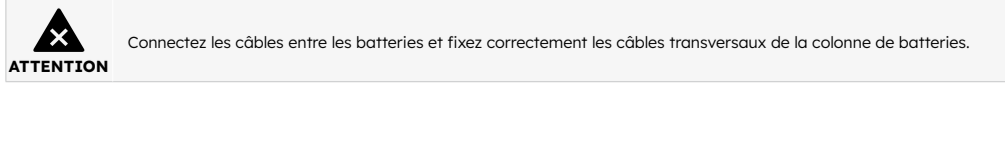

### Raccordement du câble de communication



### 2.6.3 Connexion d'autres batteries

**ATTENTION** Connectez les câbles entre les batteries et fixez correctement les câbles transversaux de la colonne de batteries.

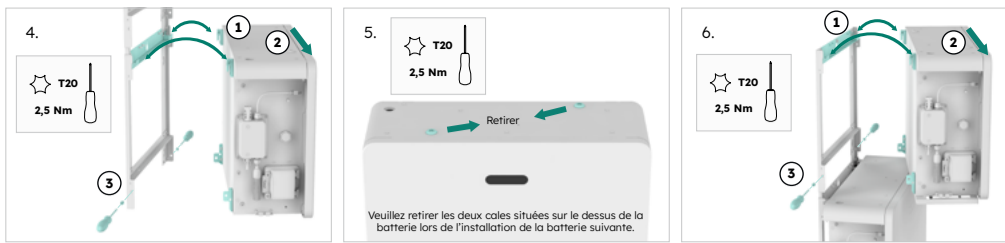

### 2.5.3 Montage de la batterie prête à l'emploi

Première installation de batterie pour une application de batterie prête à l'emploi.

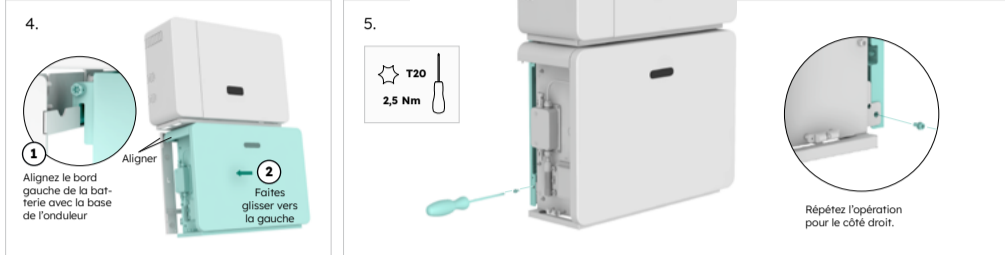
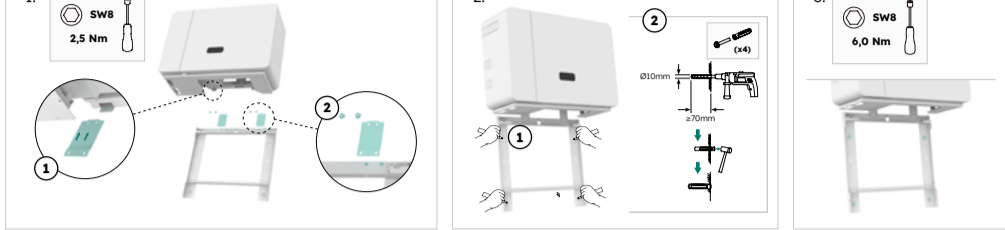

### 2.6 Raccordement électrique

#### 2.6.1 Mise à la terre

Séquence spécifique pour les câbles passant par les trous de câbles : faites passer le câble BAT+, suivi du câble de communication BMS et de la mise à la terre.

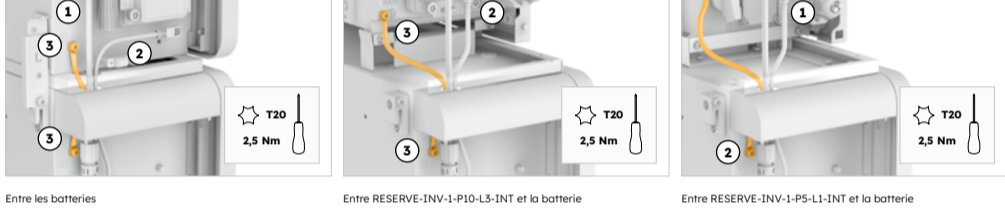

#### 2.6.2 Connexion aux pièces de l'onduleur

**AVERTISSEMENT**

Danger de mort dû au courant de court-circuit. Le fait de toucher une connexion de batterie court-circuitée peut entraîner des blessures mortelles dues à un choc électrique et à une libération massive d'énergie.

- Coupez le disjoncteur de la batterie situé en bas à gauche de la batterie.
- NE connectez PAS la borne supérieure d'une batterie à la borne inférieure, car cela entraînerait un court-circuit.

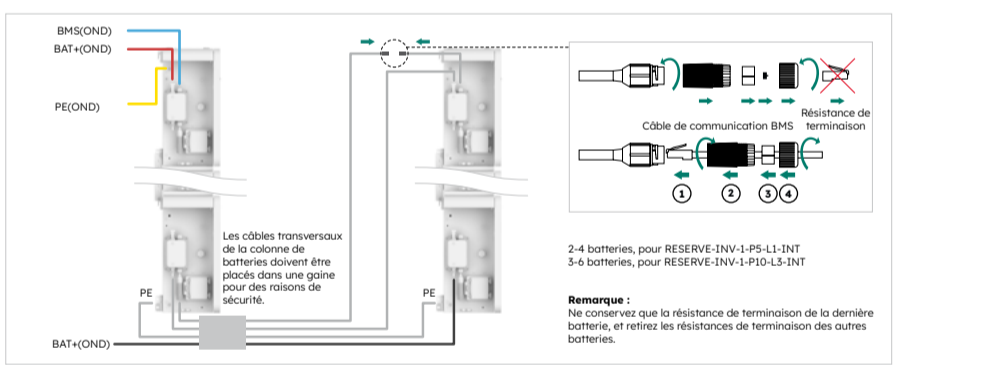

### 3.0 Mise en service



### 4.0 Montage des plaques

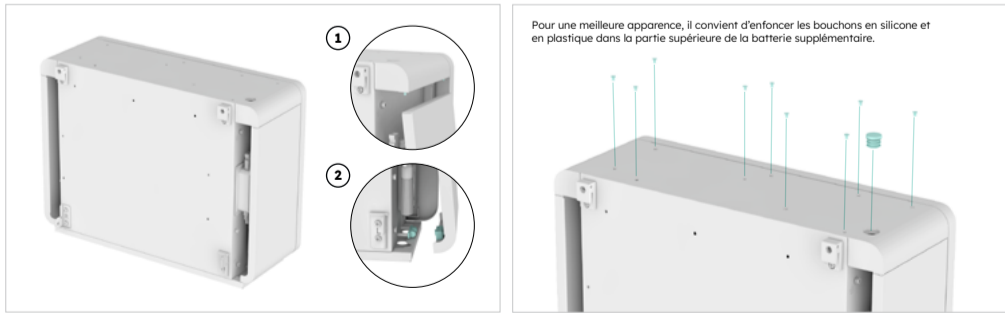

**ATTENTION** Avertissement : Ce guide d'installation rapide ne remplace pas les instructions de sécurité et d'installation, mais constitue une brève introduction à l'installation du produit. Les instructions de sécurité et d'installation font toujours office de référence.

**ATTENTION**

VOUS AVEZ BESOIN D'AIDE ?

Si vous souhaitez nous contacter directement, veuillez consulter notre site web officiel <https://sunpower.maxeon.com> pour plus d'informations.

Instructions de sécurité et d'installation de SunPower Reserve

**maxeon**  
POWERING POSITIVE CHANGE



SERVE ULTERIORE AIUTO?  
Per contattarci direttamente, visita il nostro sito web ufficiale:  
<https://sunpower.maxeon.com> per maggiori informazioni.

### 1.0 Trasporto

**ATTENZIONE** La batteria pesa 44 Kg, pertanto se viene sollevata in modo errato durante il trasporto si corre il rischio di riportare lesioni. Trasportare sempre la batteria come descritto di seguito. Maneggiare con cautela, scegliere il metodo di movimentazione più adeguato in base al peso e prestare attenzione alla sicurezza.

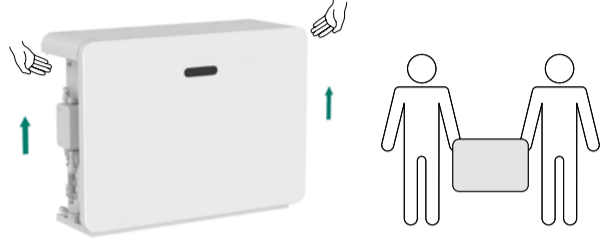

Durante il trasporto, seguire le seguenti indicazioni.

1. Per il trasporto, utilizzare l'imballaggio originale.
2. Durante il trasporto, tenere l'imballaggio lontano da fonti di pericolo e adottare le misure necessarie per proteggerlo dall'acqua.
3. Fissare l'imballaggio durante il trasporto.

### 2.0 Panoramica del prodotto

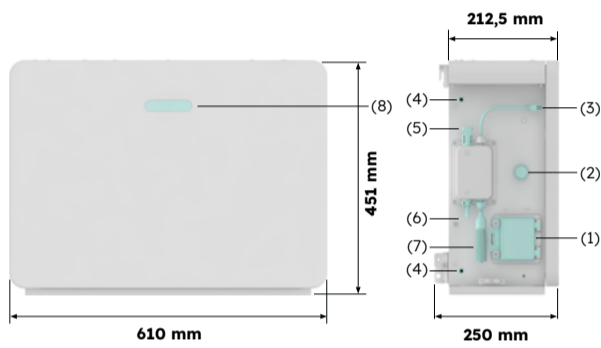

Posizione	Descrizione
1	Interruttore avviamento batteria
2	Valvola di sovrappressione
3	BMS COM (1)
4	Punto di messa a terra
5	Connettore di potenza batteria +
6	Connettore di potenza batteria -
7	BMS COM (2) (con resistore terminale)
8	Display LED batteria

### 2.1 Display LED

I tre LED presenti sul pannello frontale forniscono informazioni sullo stato di carica (SoC) o sullo stato operativo della batteria.

Stato di carica (SoC)	Descrizione
	SOC ≤ 10%
	10% < SOC ≤ 30%
	30% < SOC ≤ 50%
	50% < SOC ≤ 60%
	60% < SOC ≤ 90%
	90% < SOC ≤ 100%

Simbolo	Descrizione
	LED bianco lampeggiante
	LED bianco acceso
	LED spento
	LED giallo lampeggiante
	LED giallo acceso

Descrizione dello stato operativo
Standby: tutti i LED bianchi lampeggiano (accesi per 0,5 secondi e spenti per 0,5 secondi)
Normale: i LED bianchi sono accesi o lampeggiano (accesi per 0,5 secondi e spenti per 1,5 secondi)
Protezione: i LED gialli sono accesi o lampeggiano (accesi per 0,5 secondi e spenti per 0,5 secondi)
Errore: i LED gialli sono accesi o lampeggiano (accesi per 0,5 secondi e spenti per 0,5 secondi)
Spegnimento: tutti i LED sono spenti

### 2.2 Distanze minime

**ATTENZIONE** Per batterie aggiuntive, mantenere una distanza minima di 300 mm. Posizionamento e montaggio della batteria potrebbero variare in base alle normative locali.

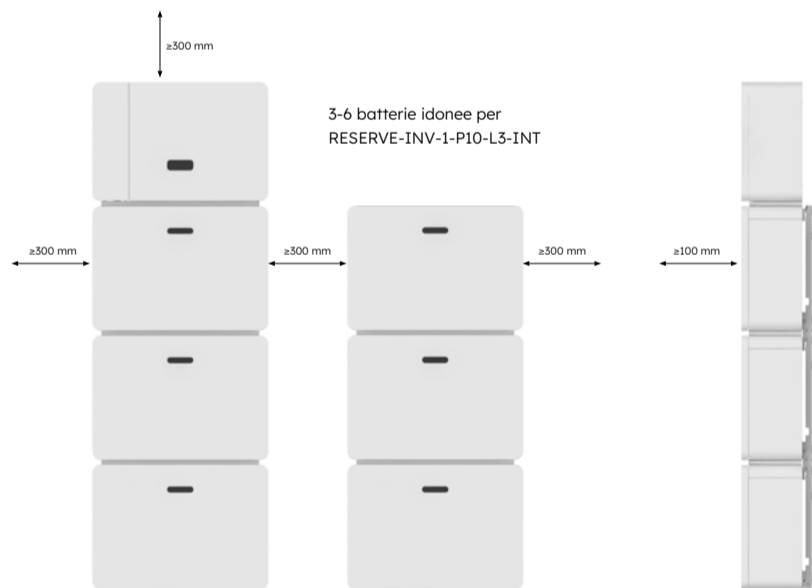
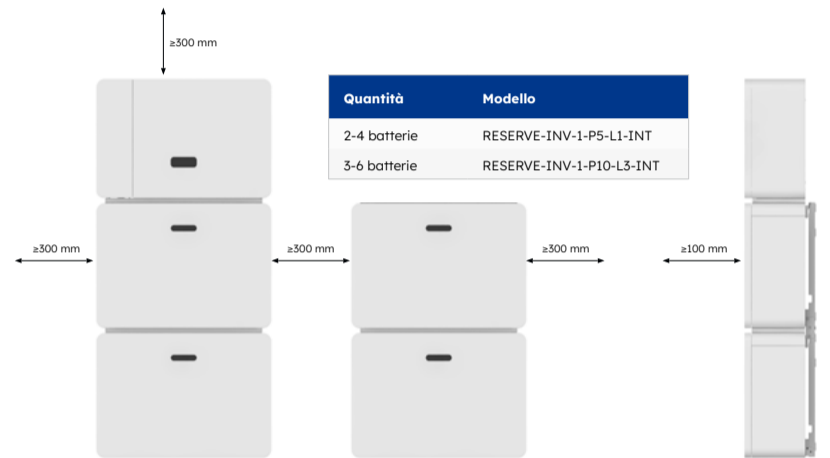

### 2.3 Dotazione

#### BATTERIA (RESERVE-BAT-1-DC-4-INT)

Batteria (x1)	Piastra laterale sx (x1)	Piastra laterale dx (x1)	Elemento di collegamento inferiore sx (x1)	Elemento di collegamento inferiore dx (x1)
Viti a testa esagonale M5x12 (x3)	Cavo di messa a terra 115 mm (x1)	Cavo di potenza batteria 205 mm (x1)	Tenditore fascette serracavo (x3)	Blocco in plastica (x1)
Tappo in silicone (x9)	Guida rapida all'installazione (x1)			

#### MONTAGGIO DELLA BATTERIA A PAVIMENTO (SPR-RESERVE-1-DC-4-INT)

Base (x1)	Piastra di collegamento a parete della base (x1)	Piastra di collegamento a parete della batteria (x1)	Tassello per fissaggio a parete (x6)	Livella a bolla d'aria piccola (x1)
Viti a testa esagonale M5x12 (x8)				

STAFFA DI MONTAGGIO A PARETE (OPZIONALE)				
Staffa di montaggio a parete (x1)	Piastra di collegamento tra le staffe di montaggio a parete delle batterie (x2)	Dado filettato M5 (x7)	Tassello per fissaggio a parete (x6)	Vite a testa esagonale con rondella grande M5x12 (x3)
Piastra di collegamento tra staffe di montaggio a parete Inverter e batteria (x2)	Livella a bolla d'aria piccola (x1)			

### 2.4 Posizione di montaggio

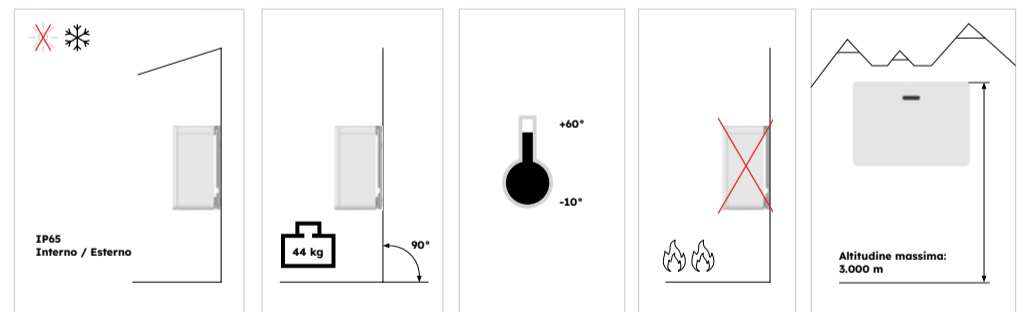

### 2.5 Installazione

#### 2.5.1 Montaggio con base

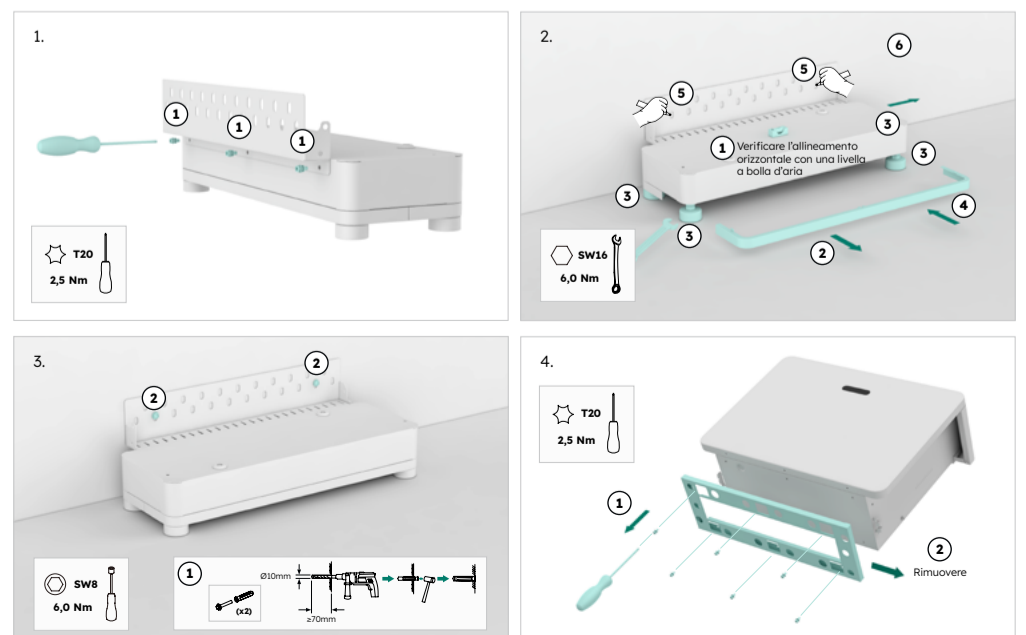

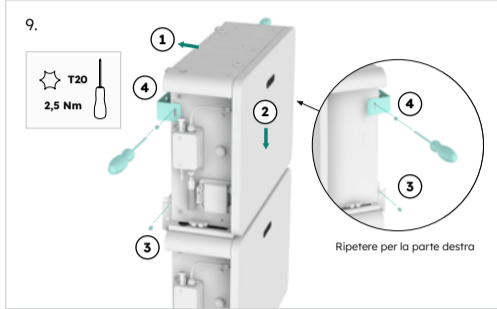
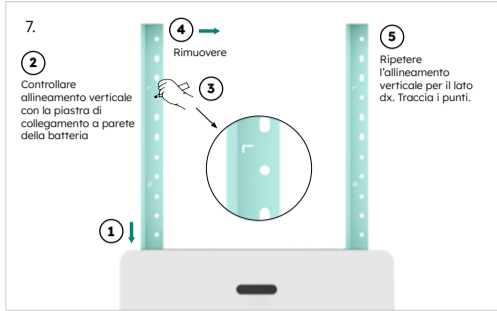
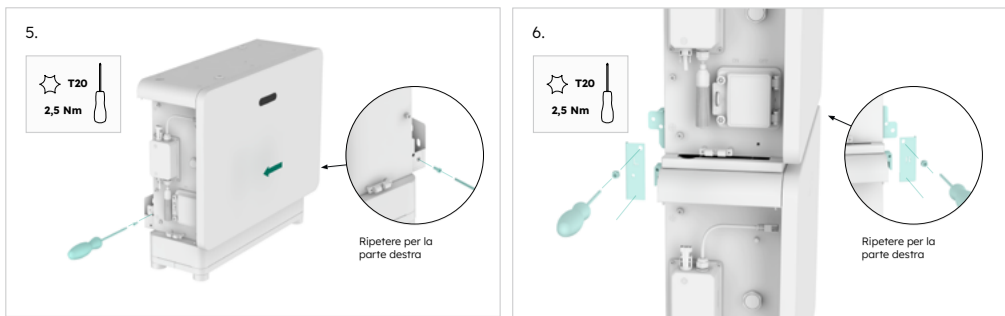

### 2.5.2 Montaggio a parete

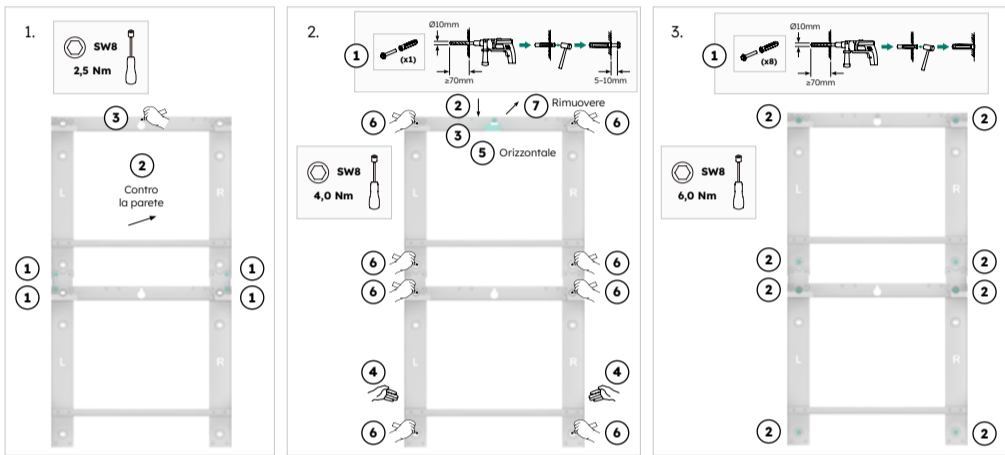

### Collegamento di potenza tra batterie

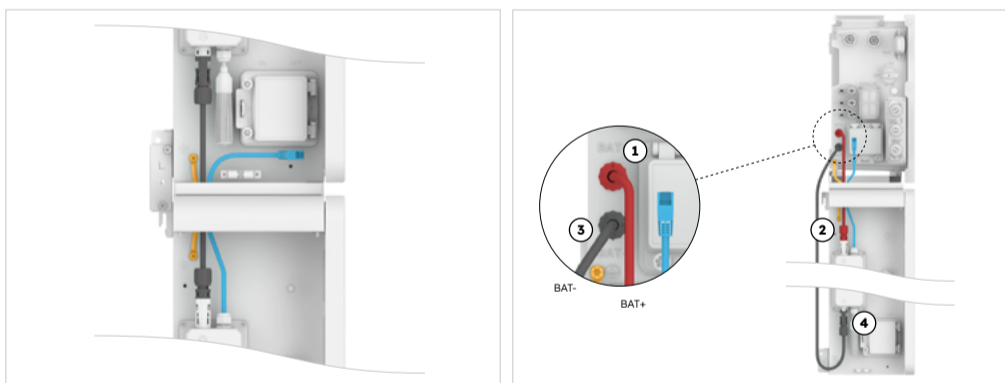

### Collegamento di potenza tra RESERVE-INV-1-P5-L1-INT e batterie

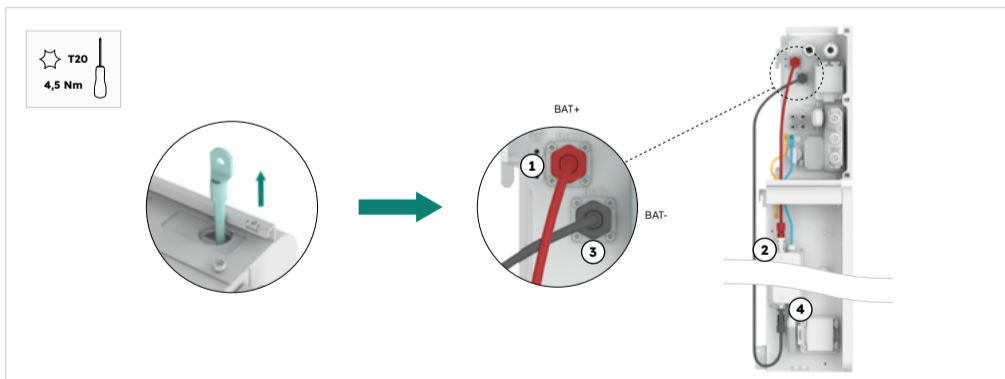

### Collegamento del cavo di comunicazione

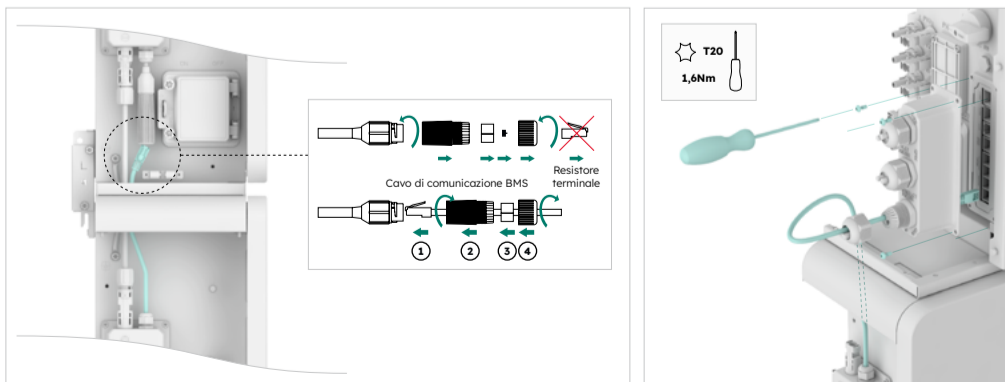

### 2.6.3. Collegare altre batterie

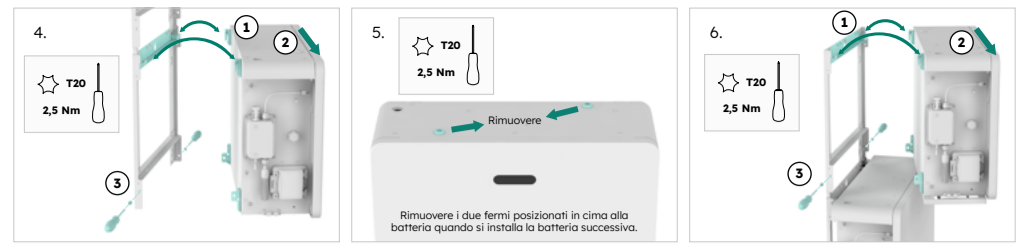
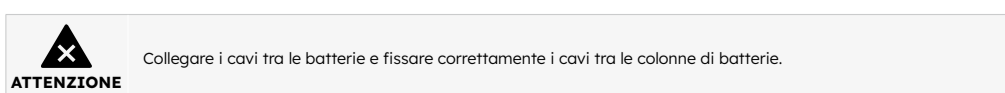

### 2.5.3 Montaggio "Battery ready"

Installazione della prima batteria per applicazioni "Battery ready".

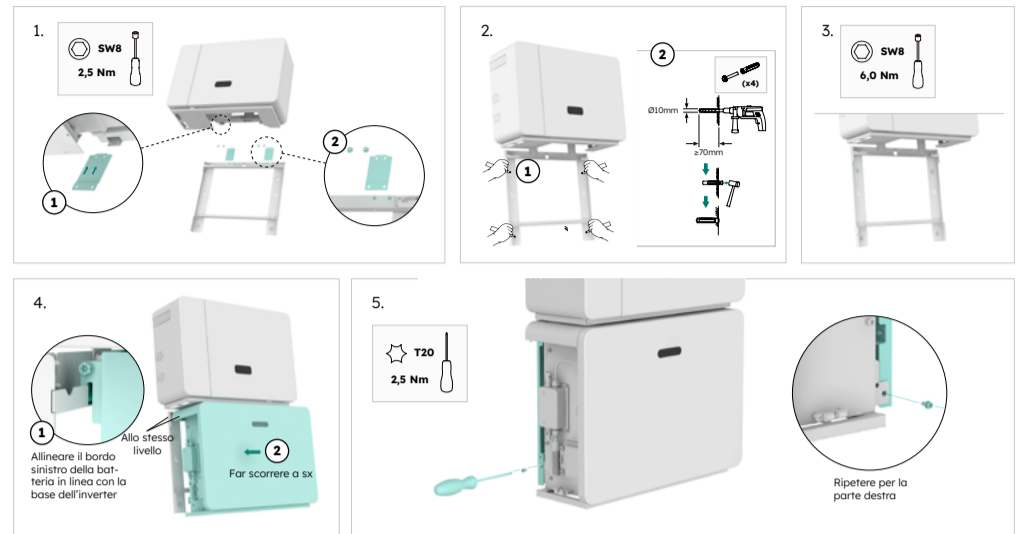

### 2.6 Collegamento elettrico

#### 2.6.1. Messa a terra

Sequenza specifica per cavi inseriti nei fori, inserire il cavo BAT+ seguito dal cavo di comunicazione BMS e dalla terra.

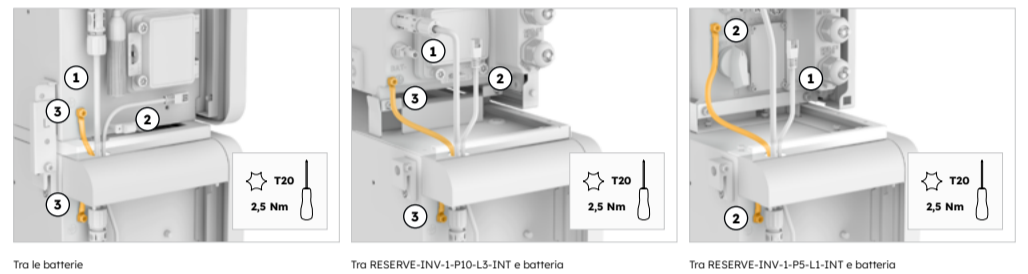

#### 2.6.2. Collegamento alle parti dell'Inverter

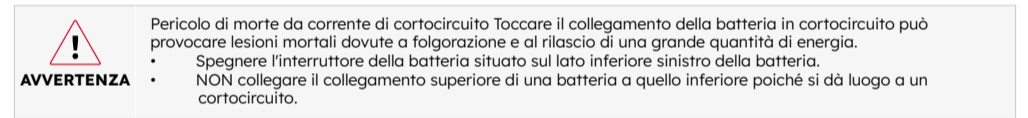

### Collegamento di potenza tra RESERVE-INV-1-P10-L3-INT e batterie

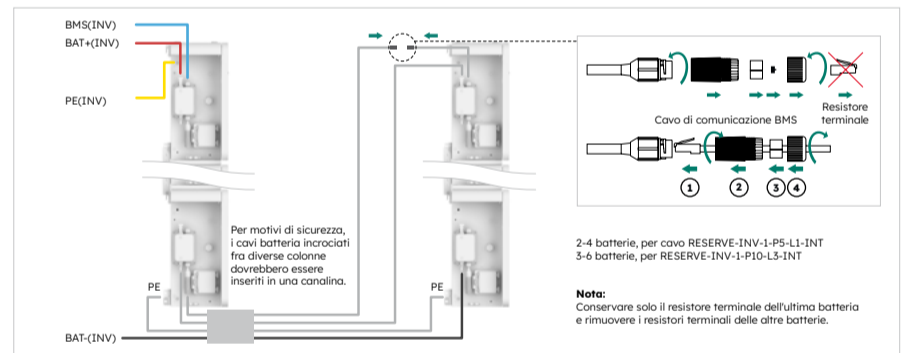

### 3.0 Messa in servizio



### 4.0 Montaggio delle piastre

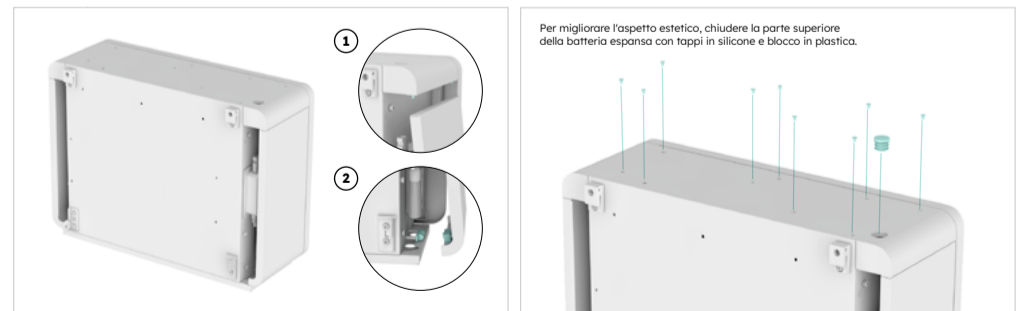

### 4.1 Montaggio dei tappi

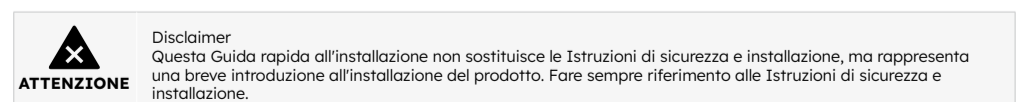

PER ULTERIORE AIUTO? Per contattarci direttamente, visita il nostro sito web ufficiale: <https://sunpower.maxeon.com> per maggiori informazioni.

Istruzioni di sicurezza e installazione per SunPower Reserve

**maxeon**  
POWERING POSITIVE CHANGE



MEER HULP NODIG?  
Wil je direct contact met ons opnemen? Ga dan naar onze officiële website,  
<https://sunpower.maxeon.com>, voor meer informatie.

## 1.0 Transport



Er is risico op letsel als de batterij, die 44 kg weegt, tijdens het transport verkeerd wordt getild. Transporteer de batterij altijd zoals hieronder beschreven. Ga voorzichtig te werk. Kies voor een methode die past bij het gewicht en neem de veiligheid in acht.

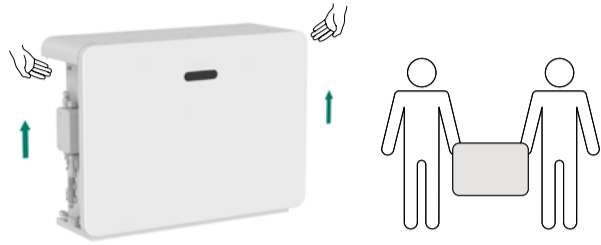

Neem tijdens het transport de volgende richtlijnen in acht:

1. Maak bij transport gebruik van de originele verpakking.
2. Houd de verpakking tijdens het transport uit de buurt van gevaarlijke bronnen en bescherm hem tegen water.
3. Zet de verpakking vast tijdens het transport.

## 2.0 Productoverzicht

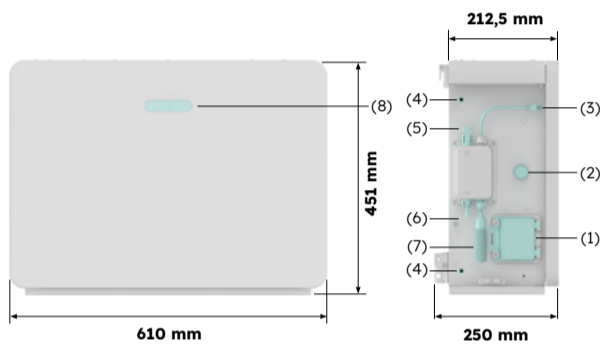

Positie	Beschrijving
1	Startonderbreker van batterij
2	Overdrukknop
3	BMS COM (1)
4	Aardingspunt
5	Voedingsconnector batterij+
6	Voedingsconnector batterij-
7	BMS COM (2) (met eindweerstand)
8	Led-display batterij

## 2.1 Led-display

De drie leds aan de voorkant van de behuizing geven informatie over de laadstatus (SOC) van de batterij, ook wel operationele status genoemd.

Laadstatus (SOC)	Beschrijving
	SOC ≤ 10%
	10% < SOC ≤ 30%
	30% < SOC ≤ 50%
	50% < SOC ≤ 60%
	60% < SOC ≤ 90%
	90% < SOC ≤ 100%

Symbol	Beschrijving
	Witte led knippert
	Witte led brandt
	Leds zijn uit
	Gele led knippert
	Gele led brandt

Beschrijving operationele status
Stand-by: alle witte leds knipperen (0,5 s aan en 0,5 s uit)
Normaal: witte leds branden of knipperen (0,5 s aan en 1,5 s uit)
Beveiliging: gele leds branden of knipperen (0,5 s aan en 0,5 s uit)
Fout: gele leds branden of knipperen (0,5 s aan en 0,5 s uit)
Uitgeschakeld: alle leds zijn uit

## 2.2 Minimale vrije ruimte



Houd bij additionele batterijen een minimale onderlinge afstand van 300 mm aan. Er kunnen lokale voorschriften van toepassing zijn op de positie en montage van de batterij.

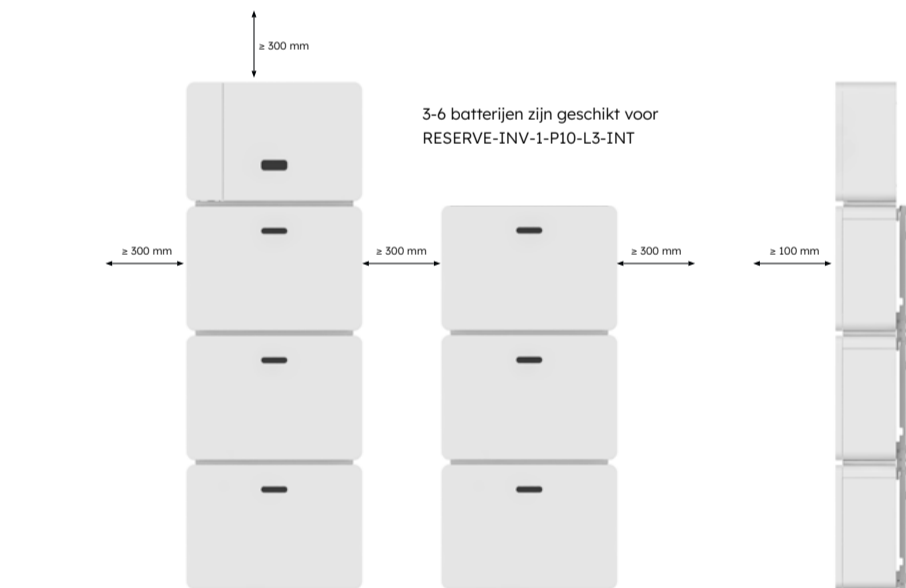
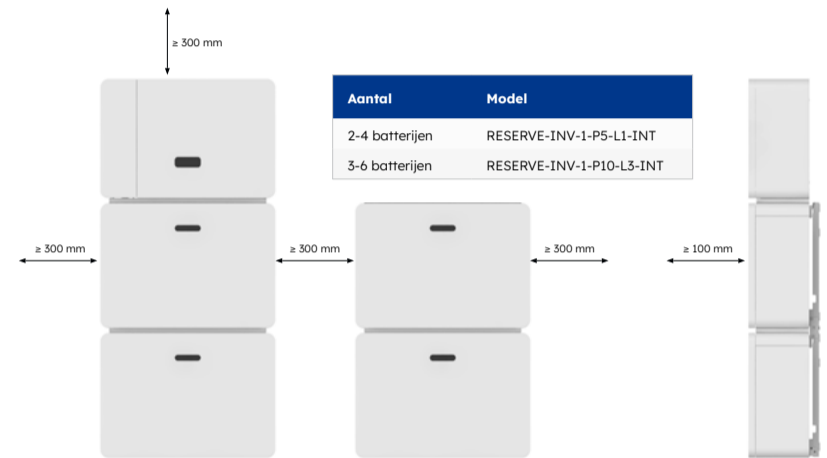

## 2.3 Wat er geleverd wordt

BATTERIJ (RESERVE-BAT-1-DC-4-INT)				
Batterij (1 x)	Linkerzijplaat (1 x)	Rechterzijplaat (1 x)	Verbindingsstuk linksonder (1 x)	Verbindingsstuk rechtsonder (1 x)
Zeskantschroeven M5x12 (3 x)	Aardingskabel 115 mm (1 x)	Batterijvoedingskabel 205 mm (1 x)	Kabelbindersluiting (3 x)	Kunststof blokkering (1 x)
Silicone plug (9 x)	Beknopte installatiehandleiding (1 x)			

VLOERMONTAGE BATTERIJ (SPR-RESERVE-1-DC-4-INT)				
Basiseenheid (1 x)	Wandverbindingsplaat van basiseenheid (1 x)	Wandverbindingsplaat van batterij (1 x)	Muuranker (6 x)	Kleine waterpas (1 x)
Zeskantschroeven M5x12 (8 x)				

MUURBEUGEL (OPTIONEEL)				
Muurbeugel (1 x)	Verbindingsplaat tussen muurbeugels van batterijen (2 x)	Flensmoer M5 (7 x)	Muuranker (6 x)	Grote zeskantige flesschroef M5x12 (3 x)
Verbindingsplaat tussen muurbeugels van omvormer en batterij (2 x)	Kleine waterpas (1 x)			

## 2.4 Montageplaats

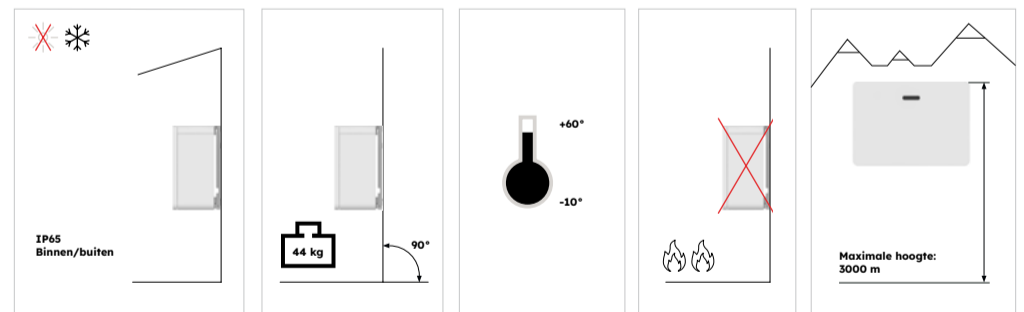

## 2.5 Installatie

### 2.5.1 Montage met basis

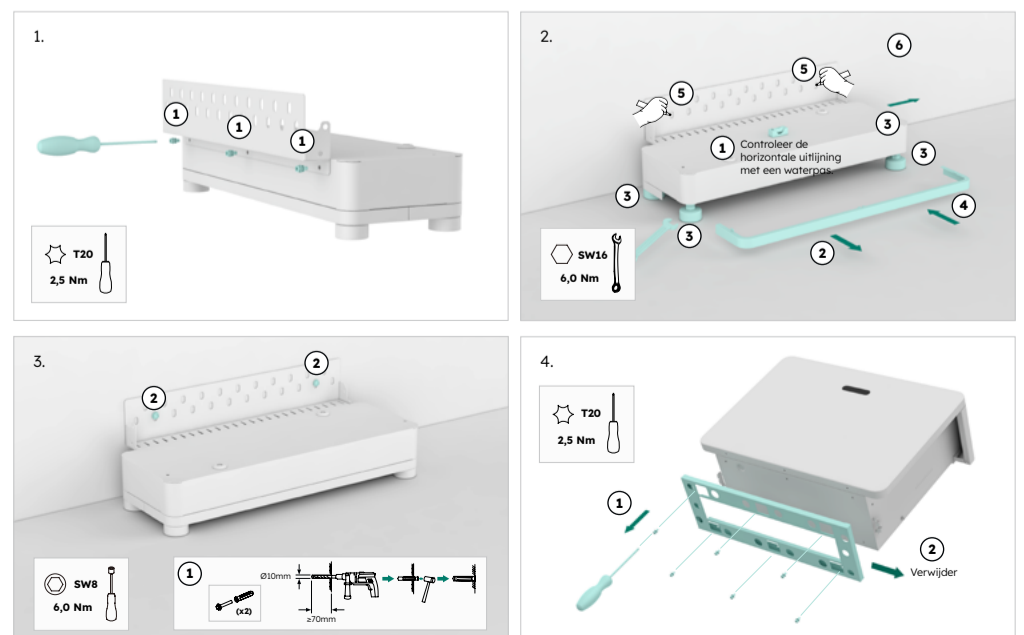

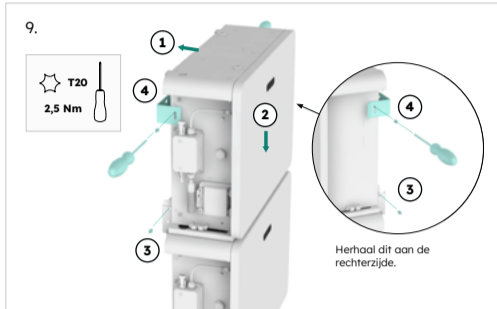
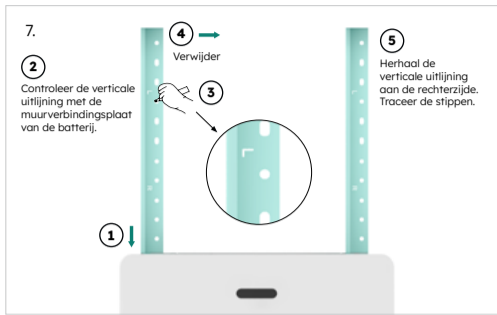
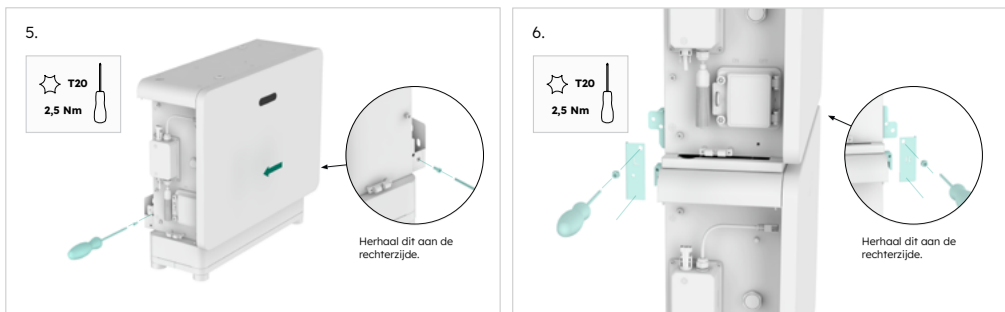

### 2.5.2 Wandmontage

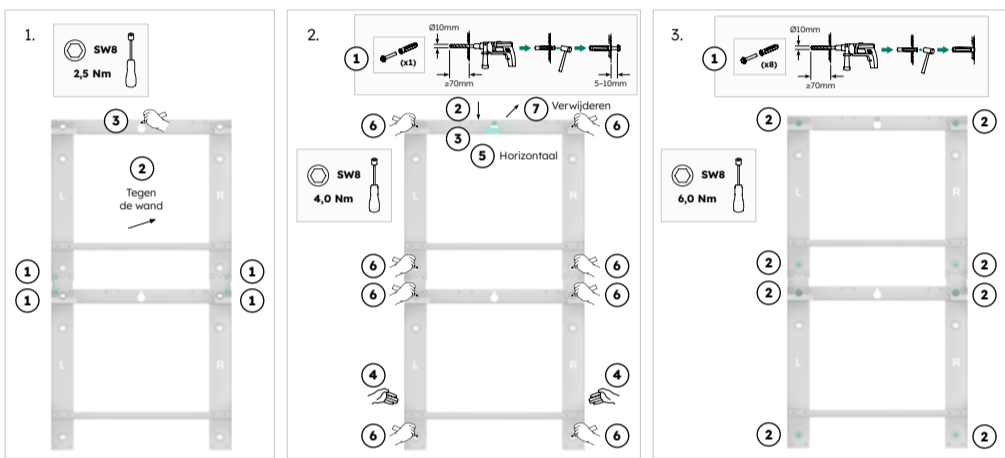

### Elektrische verbinding tussen batterijen

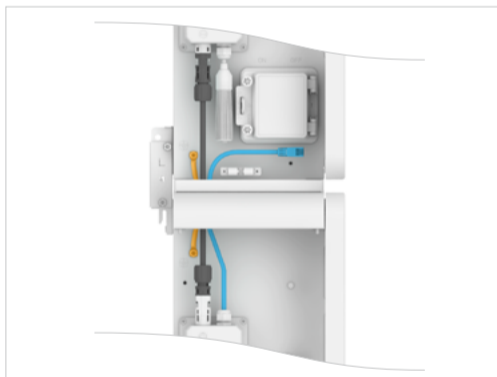

### Elektrische verbinding tussen RESERVE-INV-1-P10-L3-INT en batterijen

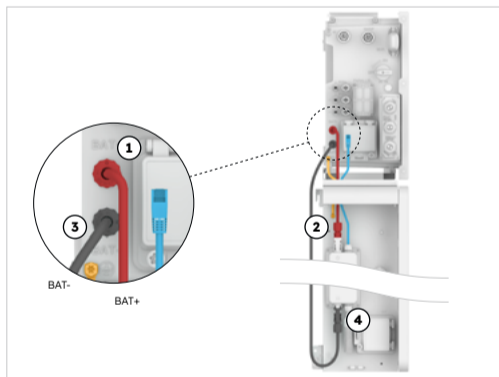

### Elektrische verbinding tussen RESERVE-INV-1-P5-L1-INT en batterijen

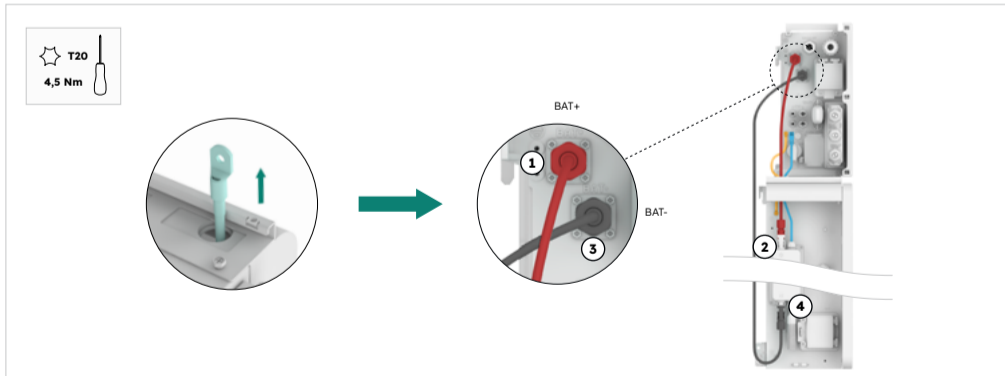

### Aansluiting van de communicatiekabel

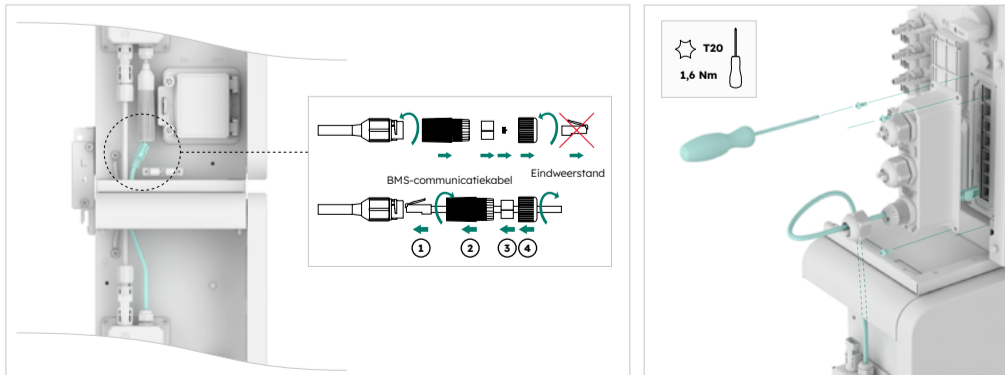

### 2.6.3. Meer batterijen aansluiten



Sluit de kabels tussen de batterijen aan en zet de kabels tussen de batterijkolommen stevig vast.

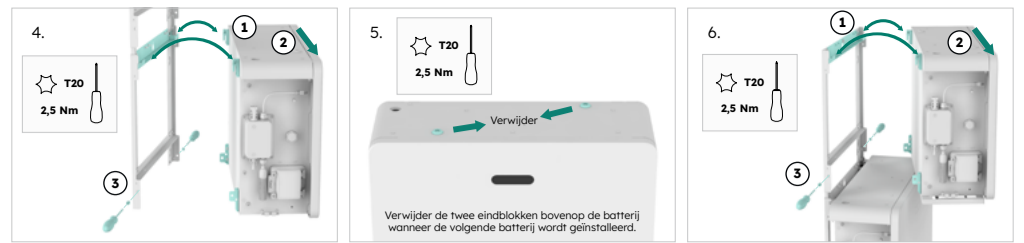

### 2.5.3 'Battery ready'-montage

Installatie eerste batterij voor 'battery ready'-toepassing.

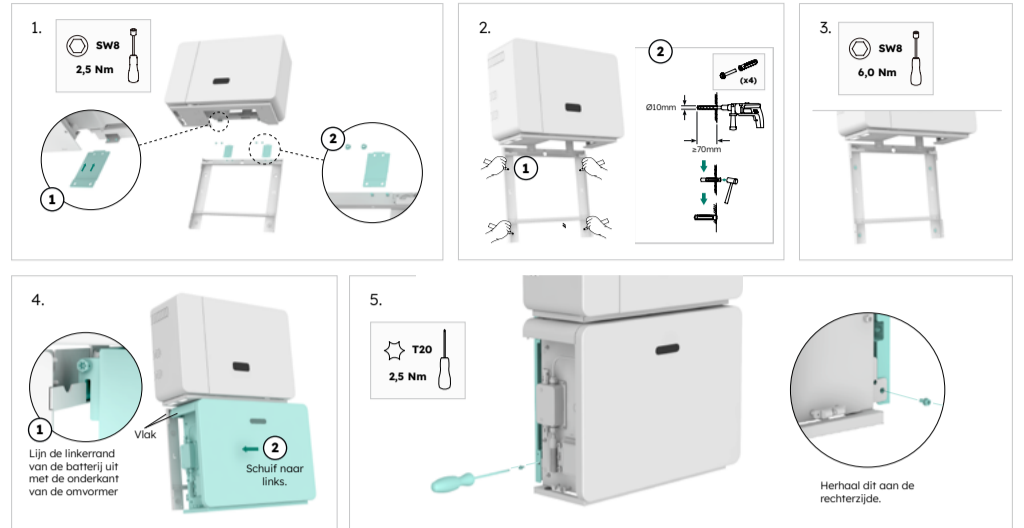

### 2.6 Elektrische aansluiting

#### 2.6.1. Aarding

Specifieke volgorde voor kabelgeleiding door de openingen: voer de BAT+-kabel door, gevolgd door de BMS-communicatiekabel en de aardingskabel.

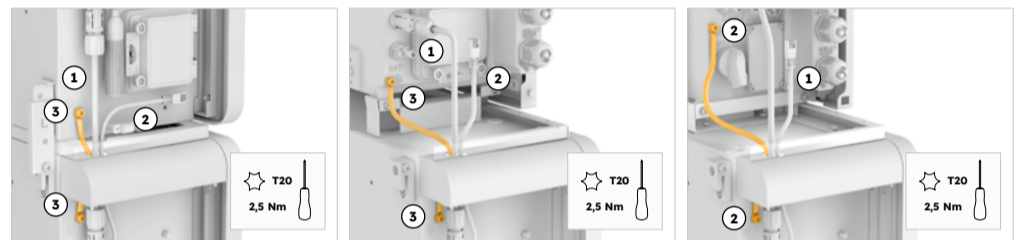

#### 2.6.2. Aansluiten op de onderdelen van de omvormer



Levensgevaar door kortsluitstroom Het aanraken van de kortgesloten batterijaansluiting kan leiden tot dodelijk letsel als gevolg van een elektrische schok en het vrijkomen van grote hoeveelheden energie.

- Schakel de lastscheider links onder op de batterij uit.
- Sluit de bovenste verbinding van een batterij NIET aan op de onderste verbinding, want dit leidt tot kortsluiting.

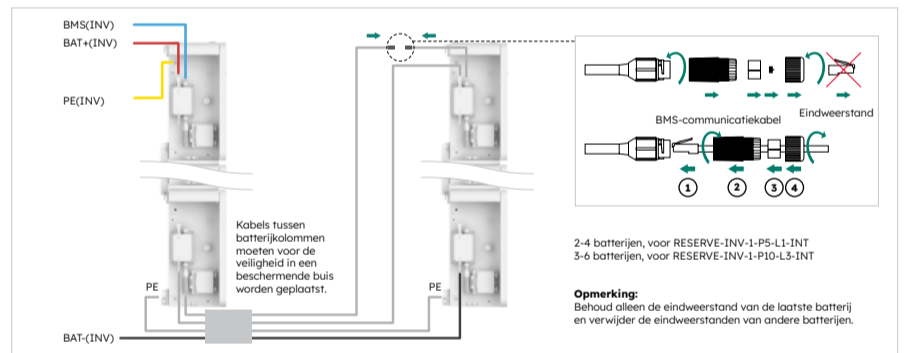

### 3.0 Inbedrijfstelling

Inschakelen:

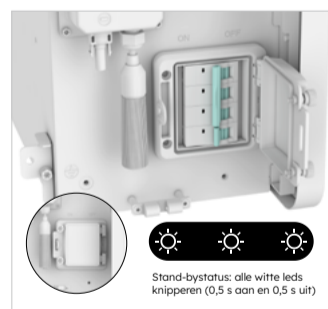

Uitschakelen:

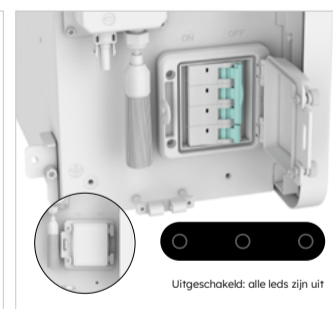

### 4.0 Montage van de zijplaten

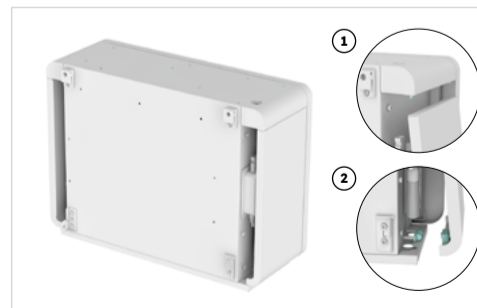

### 4.1 De pluggen monteren

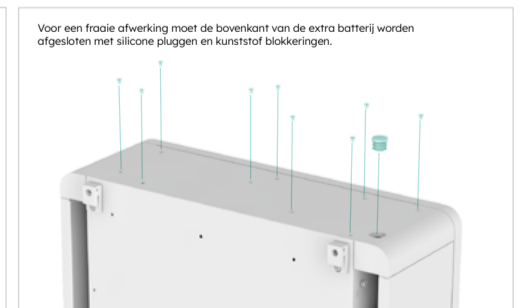

Disclaimer: Deze beknopte installatiehandleiding dient niet ter vervanging van de veiligheids- en installatie-instructies. Het is een korte inleiding op de installatie van het product. Je moet nog steeds de veiligheids- en installatie-instructies raadplegen.



MEER HULP NODIG?  
Wil je direct contact met ons opnemen? Ga dan naar onze officiële website, <https://sunpower.maxeon.com>, voor meer informatie.

Veiligheids- en installatie-instructies voor SunPower Reserve

**maxeon**  
POWERING POSITIVE CHANGE